

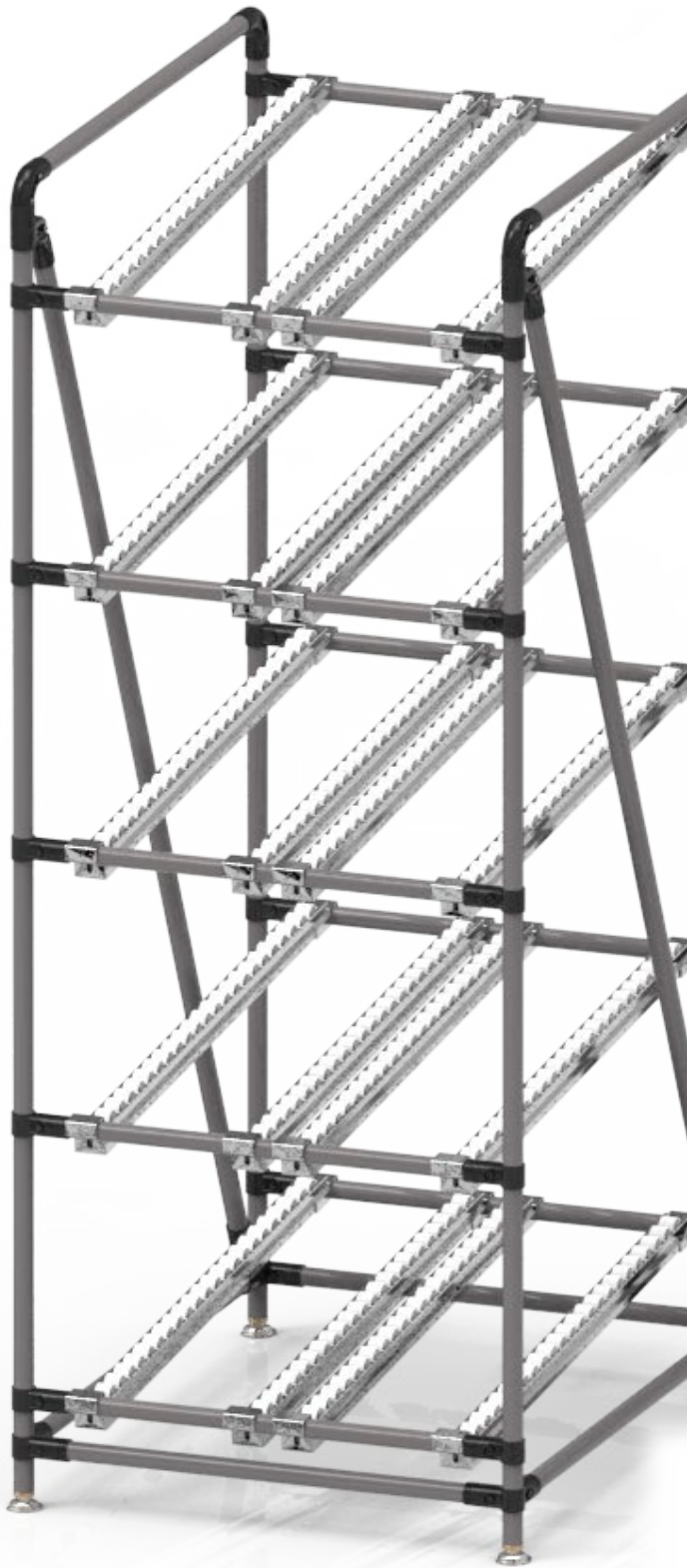

Sistema Tubular de Acero para Flujo Continuo de Materiales





CONTENIDO

TUBOS	5
UNIONES METÁLICAS	6
MÉTODOS DE UNIÓN	8
ACCESORIOS DE PLÁSTICO	11
ACCESORIOS METÁLICOS	13
SUPERFICIES	18
PATAS, AJUSTADORES e INSERTOS	19
CUBIERTAS PARA TUBO	20
MICAS PROTECTORAS	21
TORNILLERÍA	22
ROLLERS	23
ÁNGULOS y GUÍAS	29
RODAMIENTOS	31
GAVETAS	35
CONTENEDORES	36
CARRO Z	38
INFORMACIÓN TÉCNICA	39
GALERIA	42

SUPERMERCADOS DINÁMICOS

Elimine los grandes almacenes, utilizando los supermercados dinámicos, menos voluminosos que los almacenes tradicionales de pallets y sus grandes contenedores.

Los supermercados dinámicos, totalmente modulares y hechos a la medida, son ideales, ya que se logra más orden y una importante ganancia de espacio.

Los supermercados dinámicos se ubican a unos metros de las líneas de ensamble. Son una fase intermedia entre el almacén o proveedores y las líneas de producción.



CARROS SURTIDORES

Hacer que las piezas lleguen a la línea de producción, sin la utilización de los montacargas, remplazados por "los trenecitos" o carros surtidores.

Haga el movimiento de materiales más flexible, rápido, con seguridad y mucho más económico que usando los montacargas, los trenecitos o carros surtidores solamente transportan lo que van a necesitar los operadores justo a tiempo.

Los carros surtidores de estructura ligera, se abastecen tomando las piezas de los supermercados y pueden ser empujados fácilmente por los operadores o jalados por carros de arrastre hacia las líneas de producción o ensamble.



FLOW RACKS • RACKS DE GRAVEDAD

Perfectos para que el material esté justo al alcance de la mano de los operarios. Para reducir los movimientos inútiles en la línea de producción, se pueden implementar los flow racks dinámicos con caída por gravedad. Con estos flow racks se optimizan los espacios, logrando una visión completa del flujo de producción.

Los flow racks o racks de gravedad permiten la liberación de espacios, por lo que ahora es posible implementar el flujo de una pieza y así poder ensamblar pequeños lotes de modelos diferentes, en la misma línea de producción.



MESAS DE TRABAJO • CELDAS DE MANUFACTURA

Diseñadas ergonómicamente, optimizan el espacio y se adaptan al proceso productivo, fácilmente modificables para implementar mejoras. Ayudan al flujo de operaciones y materiales y reducen los movimientos innecesarios y tiempos de espera.

Ideales para diseñar células de trabajo en forma de "L" o "U" que facilitan y optimizan la producción, eliminando desperdicios.

Estas mesas pueden accessorizarse de manera que todos los elementos que participan en el proceso productivo se encuentren en su lugar y faciliten el trabajo de manufactura y que en combinación con racks de gravedad faciliten la entrada y salida de materiales de un proceso a otro.



AYUDAS VISUALES

Son una excelente herramienta para dar a conocer información vital que debe ser desplegada en el piso de producción.

Estas ayudas visuales, son estructuras que pueden ser colocadas en las estaciones de trabajo para capacitar a los operarios en los métodos de ensamble y estándares de producción.

Con una gran versatilidad en el diseño y ajustándose a las necesidades de comunicación en la organización, las ayudas visuales se pueden utilizar en oficinas, comedor, almacén o en donde se necesite difundir información.



COMPONENTES DEL SISTEMA



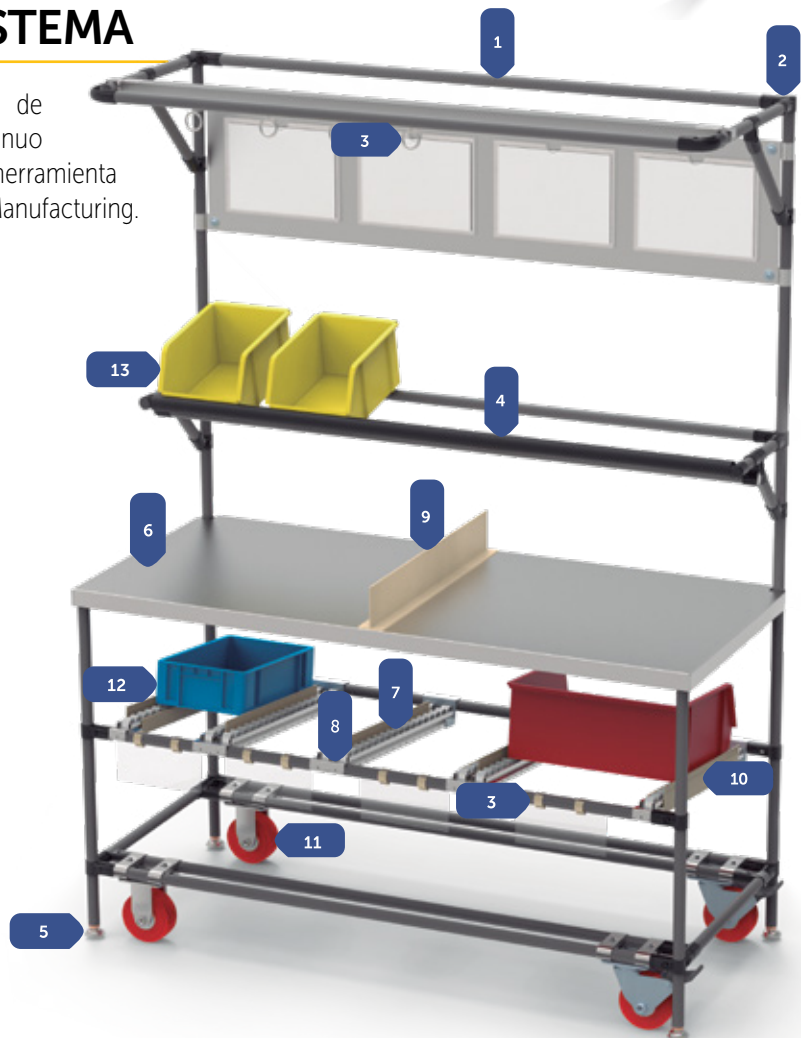

Las estructuras **Lean** son un sistema de componentes diseñadas para facilitar el flujo continuo de materiales a las líneas de producción, son una herramienta ideal para la implementación de la filosofía Lean Manufacturing.

- 1 • TUBOS
- 2 • UNIONES
- 3 • ACCESORIOS
- 4 • CUBIERTAS PROTECTORAS PARA TUBOS
- 5 • PATAS AJUSTADORAS
- 6 • SUPERFICIES
- 7 • ROLLERS
- 8 • MONTURAS
- 9 • ÁNGULOS
- 10 • GUÍAS
- 11 • RUEDAS
- 12 • CONTENEDORES
- 13 • GAVETAS



TUBOS

Los tubos están hechos de acero y recubiertos con resina ABS. Este recubrimiento hace que al ensamblar las uniones no se muevan ni separen.

-  Excelente durabilidad.
-  Resistencia a los impactos, solidez y ligereza.
-  Interior tratado con un recubrimiento anti-corrosivo.
-  Poco mantenimiento (limpieza con franela húmeda).

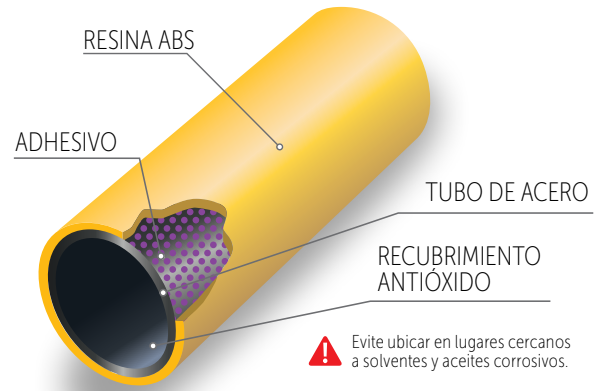

TUBO	CÓDIGO	COLOR	DÍAMETRO	ESPESOR	PESO	TRAMO
ABS ESTÁNDAR	MP-1012	GRIS PROFUNDO	Ø 28 mm	0.7 mm	460 g/m	4 m
	MP-1070	IVORY				
	MP-1072	AZUL				
	MP-1073	GRIS				
	MP-1077	BLANCO				
	MP-1100	IVORY		1.0 mm	676 g/m	
	MP-1101	VERDE				
	MP-1102	AZUL				
	MP-1103	GRIS				
	MP-1105	CAFÉ				
	MP-1106	NEGRO				
	MP-1107	BLANCO				
	MP-1108	AMARILLO				
	MP-1109	NARANJA				
	MP-1110	ROJO				
	MP-1111	ROSA				
	MP-1112	GRIS PROFUNDO				
	MP-1113	GRIS OSCURO				
	MP-1200	IVORY		2.0 mm	1.265 g/m	
	MP-1201	VERDE				
	MP-1202	AZUL				
MP-1203	GRIS					
MP-1206	NEGRO					
MP-1207	BLANCO					
MP-1212	GRIS PROFUNDO					
MP-1213	GRIS OSCURO					
⚡ ANTIESTÁTICO	AP-1100	NEGRO	1.0 mm			676 g/m
	AP-1110	IVORY				
	AP-1111	GRIS				
	AP-1112	GRIS OSCURO				
⚡ CONDUCTIVO	CP-1100	NEGRO	1.0 mm	676 g/m		
⚡ ACERO INOXIDABLE	ST-1070	INOX	0.7 mm	448 g/m		
	ST-1110	INOX	1.1 mm	708 g/m		
SLIDE (CARA PLANA)	SL-1010	IVORY	1.0 mm	767 g/m		
	SL-1012	AZUL				
	SL-1013	GRIS				
⚡ ALUMINIO	AL-1102	ALUMINIO	1.1 mm	380 g/m		

⚡ ANTIESTÁTICO El tubo antiestático presenta resistencia de la superficie $10^8\Omega \sim 10^{10}\Omega$

⚡ CONDUCTIVO El tubo conductivo presenta resistencia de la superficie $\sim 10^2\Omega$

UNIONES MÉTÁLICAS

Las uniones metálicas son componentes de acero que sirven para unir los tubos. Disponibles en tres acabados: pintura negra electrostática, níquel y zinc. Se ensamblan y desensamblan fácilmente utilizando tornillos M-6 y tuercas tipo T, que son ajustadas utilizando una llave Allen, conectando con facilidad y exactitud los tubos para armar las soluciones propuestas para el flujo continuo de materiales.

Cada unión tiene una función específica y se seleccionan de acuerdo al tipo de montaje que se requiere ensamblar.

La temperatura que pueden resistir es de -10°C a 80°C .

Todas las uniones las puede encontrar en los siguientes acabados:





MÉTODOS DE UNIÓN

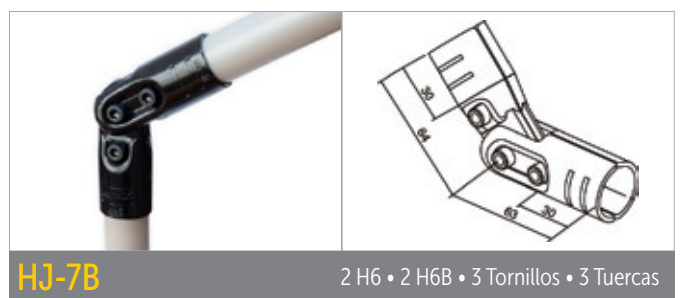
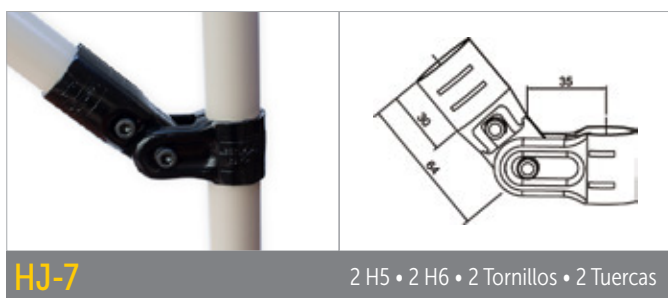
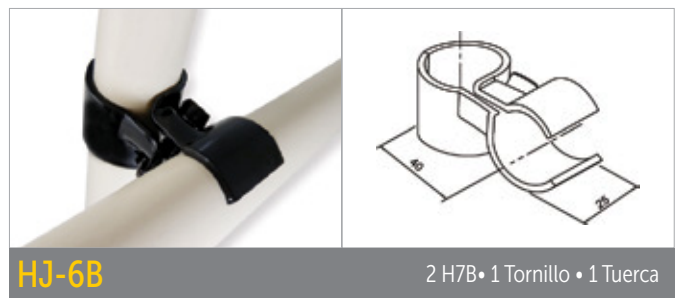
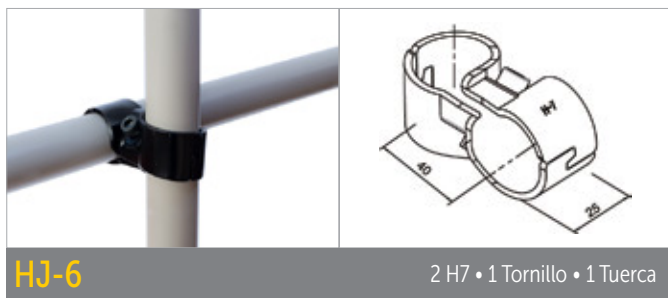
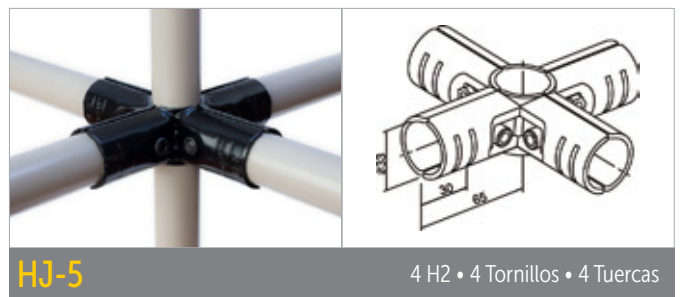
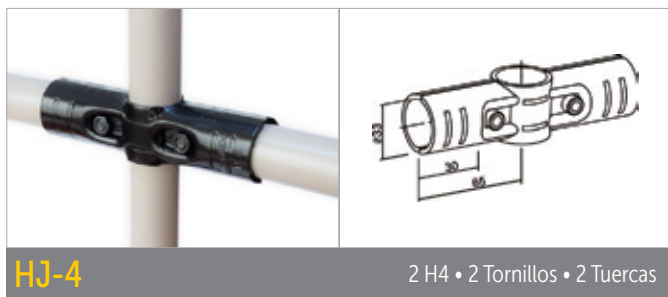
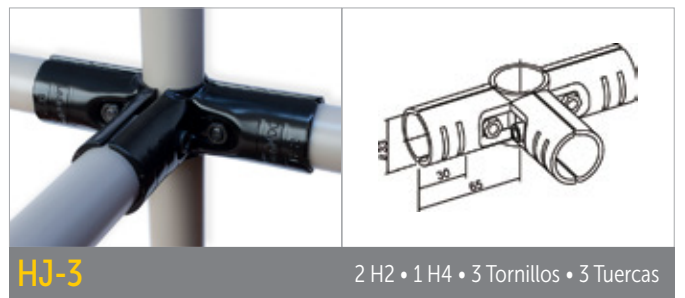
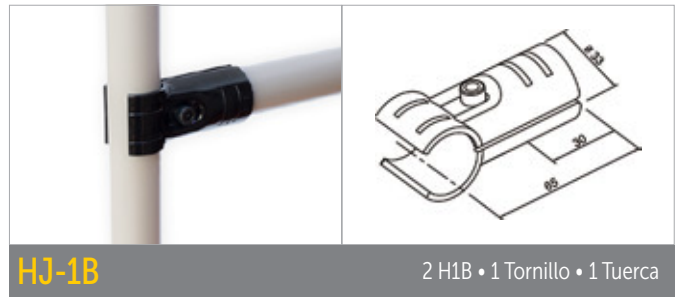

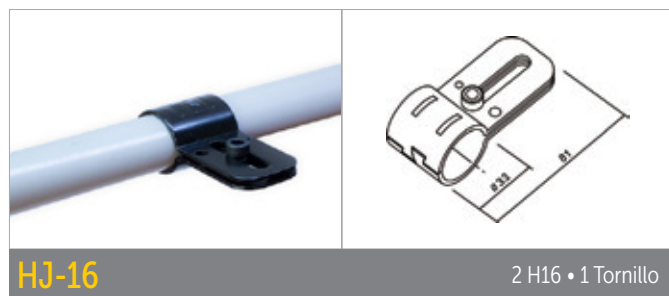
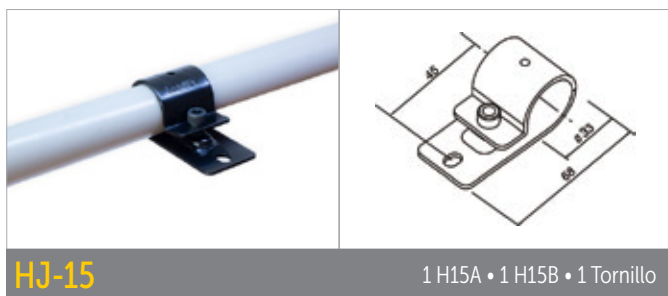
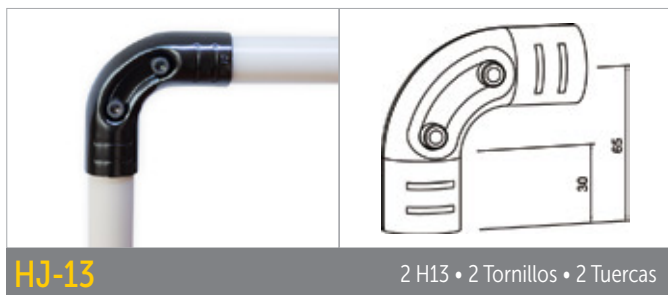
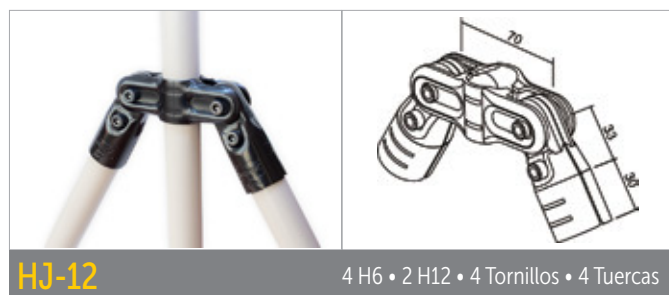
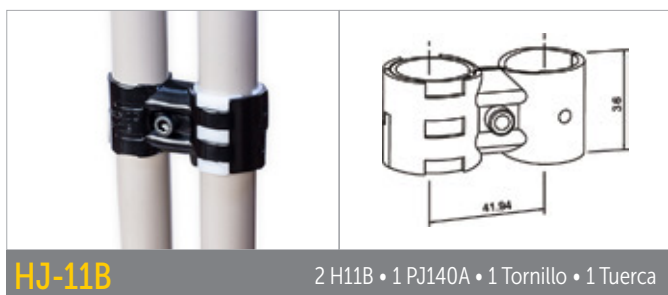
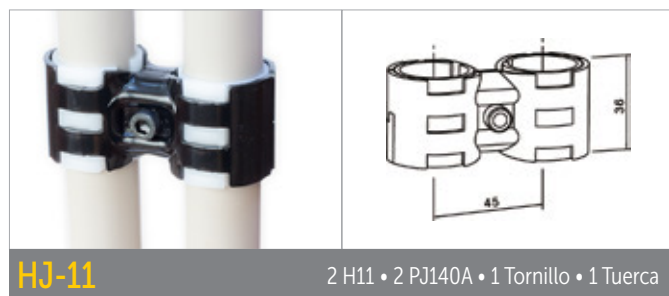
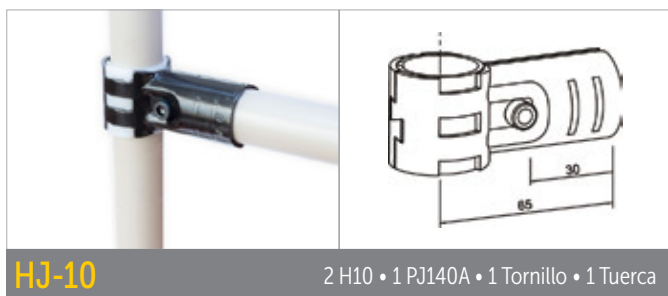
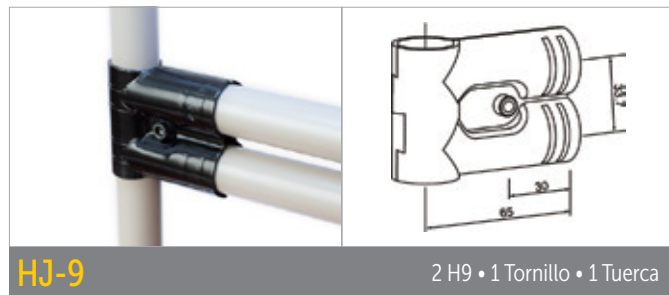
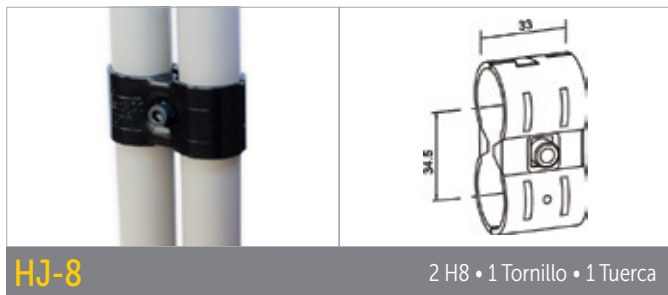

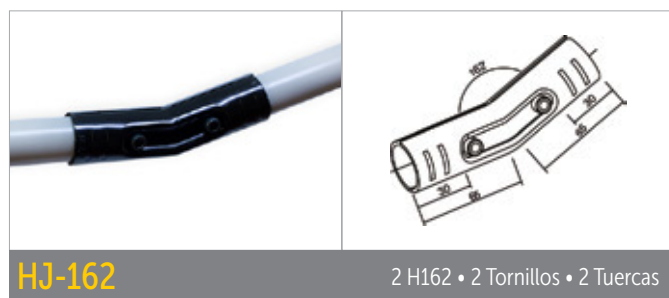
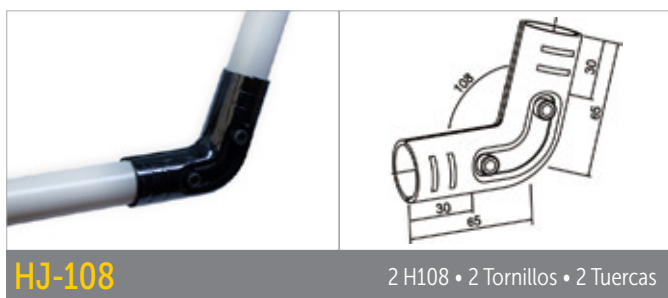
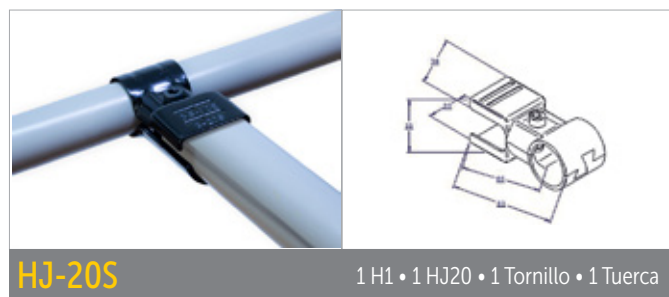
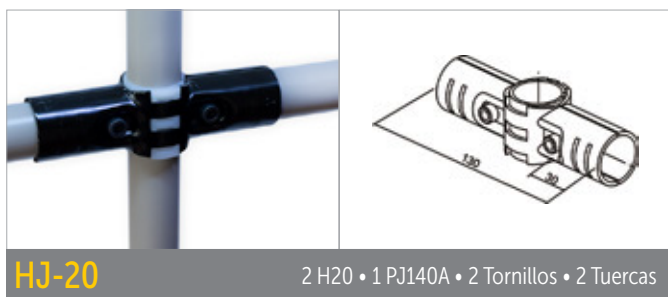
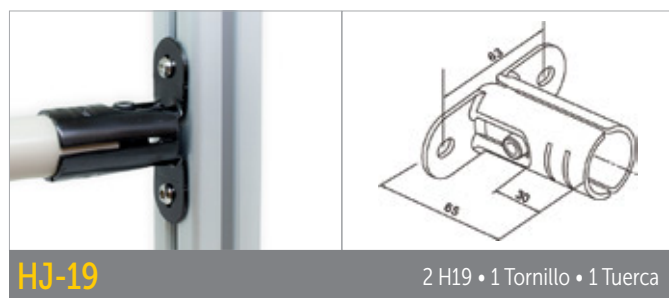
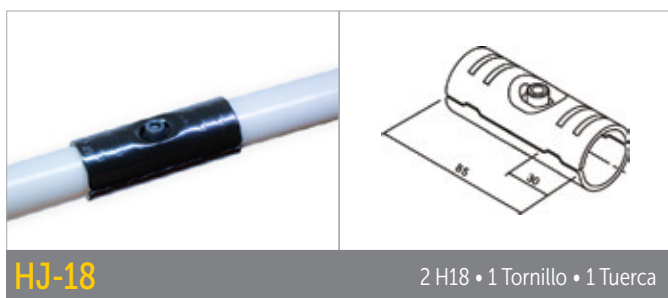
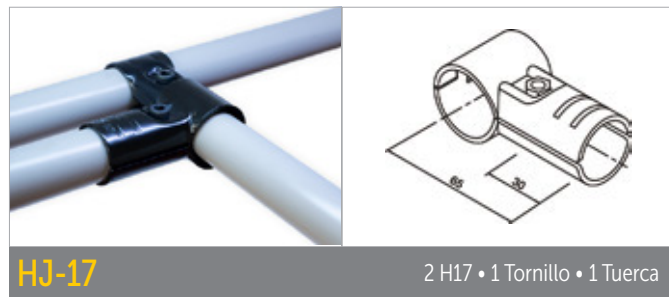
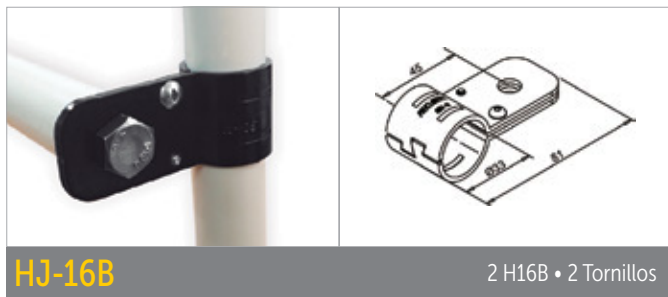

ACCESORIOS DE PLÁSTICO

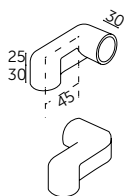

PJ-100 R/L

200
42g

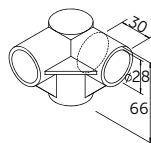

PJ-104 C

150
48g

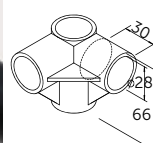

PJ-104D

150
46g

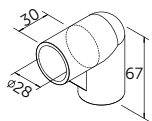

PJ-105

220
34g

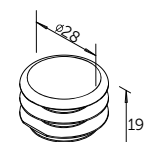

Para Tubo INOX 0.7mm (ST-1070)

⚡ disponible en ESD

PJ-110

2,500
3.4g

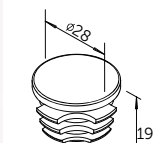

⚡ disponible en ESD

PJ-110ABK

2,500
3.4g

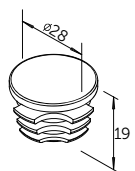

PJ-110AIV

2,500
3.4g

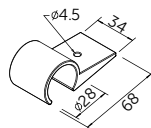

PJ-113

600
12g

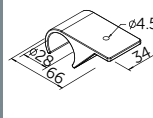
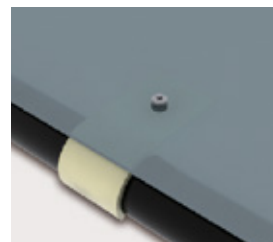

PJ-113B

600
21g

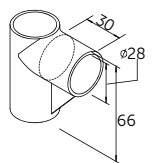

PJ-118

250
30g

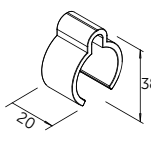

⚡ disponible en ESD

PJ-138BBK

1,500
5.4g

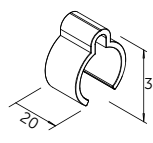

PJ-138BIV

2,000
5.4g

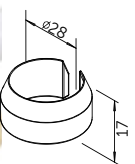

PJ-138C

2,000
3.4g

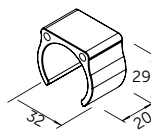

PJ-138SIV

2,000
4.3g

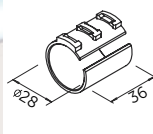

PJ-140A

1,000
6g

PJ-140S 📦 400
⚖️ 10.6g

PJ-141 📦 2,000
⚖️ 6.5g

PJ-146IV 📦 600
⚖️ 10.7g

PJ-146GR 📦 600
⚖️ 10.7g

PJ-149IV 📦 1,500
⚖️ 7.4g

PJ-149BK 📦 1,500
⚖️ 7.4g

PJ-159 Caja con 250 pzs
Peso x pza: 18 g 📦 250
⚖️ 18g

PJ-180 📦 1,000
⚖️ 14g

PJ-199IV 📦 1,000
⚖️ 8g

PJ-201IV 📦 600
⚖️ 16g

PJ-202IV 📦 600
⚖️ 16g

PJ-5131 📦 180
⚖️ 30g

CG-0150BK 📦 1
⚖️ 182g

PH-5001A 📦 160
⚖️ 40g

PH-5001B 📦 160
⚖️ 38g

ACCESORIOS METÁLICOS



AT-007

50
200g



BALLTRANSFER 1

200
200g

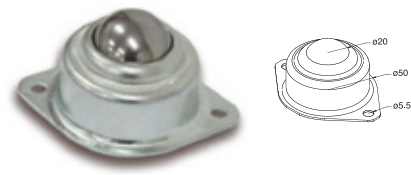

BALLTRANSFER 12A

200
170g

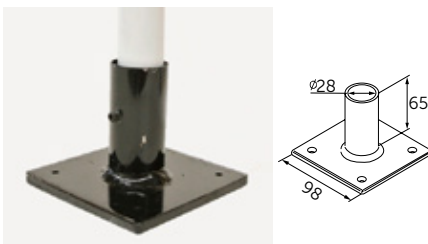

BS-201

12
612g

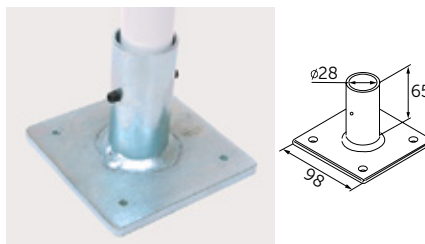

BS-202

12
606g

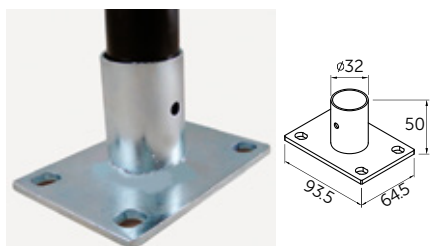

BS-203

12
350g



H-22

80
70g



H-25

100
82g



H-26

50
98g

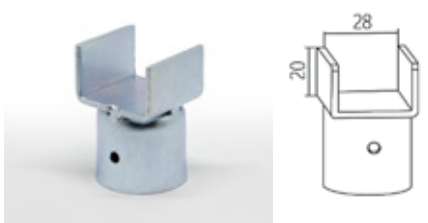

H-28

100
72g



H-32

50
35g

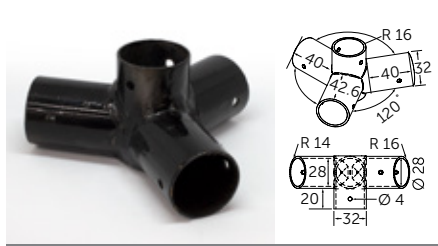

J-33

20
180g

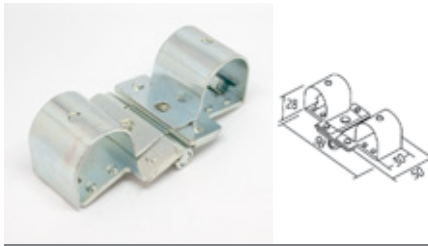

MT-1011

100
90g

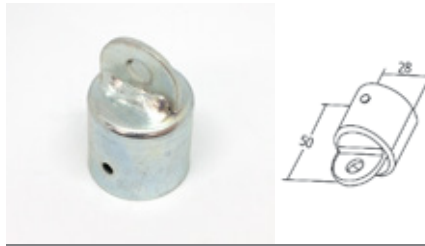

MT1012J

100
60g

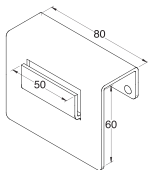

MT-1012L

150
87g

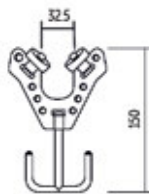

MT-1012M

100
192g

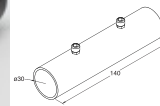

MT-1200

100
203g

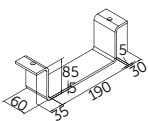

MT-5100

25
908g

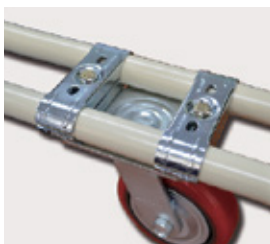

MT-5019

150
106g

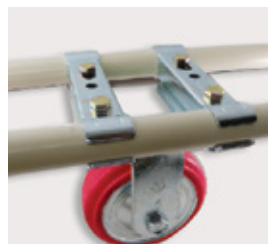

MT-5109W

120
120g

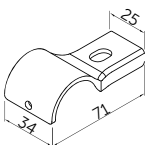

MT-5110

300
66g

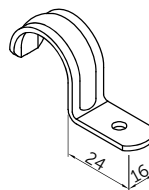

MT-5111

400
20g

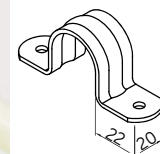

MT-5112

200
26g

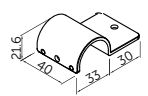
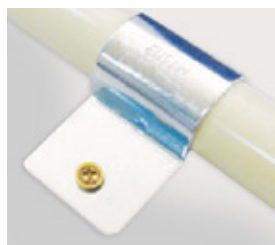

MT-5113

150
62g

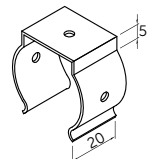

MT-5114

400
14g

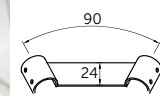
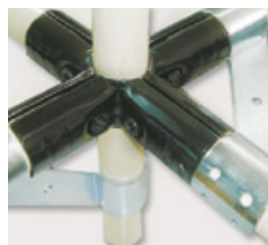

MT-5116

50
110g

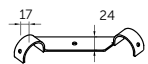

MT-5117

50
72g

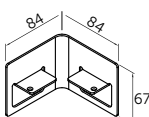

MT-5118

30
176g

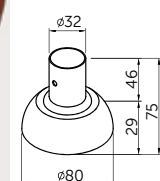

MT-5119

20
226g

CÓDIGO	CANTIDAD	L	PESO X PIEZA
ME-1009	5	NA	244 g
ME-1008	8	100	1,172 g
ME-1015	8	150	2,000 g
ME-1016	8	200	2,286 g

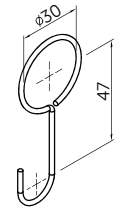
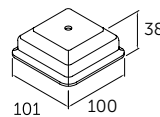
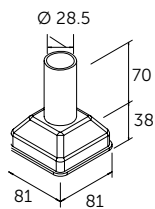
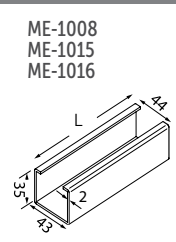
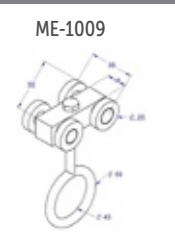

MT-5119S/M/L 50 400g

MT-5119W 35 330g

MT-5120 1,000 8g

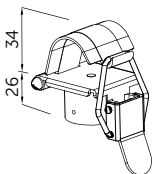
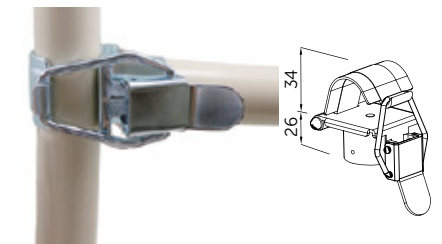
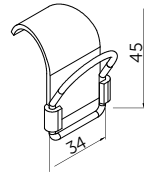
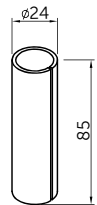

MT-5123 150 74g

MT-5125 150 48g

MT-5126 200 126g

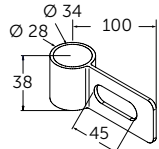
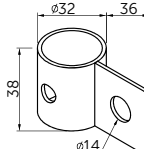
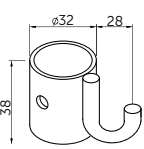

MT-5127SV/BK 100 70g

MT-5128 100 94g

MT-5129 60 150g

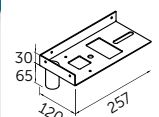
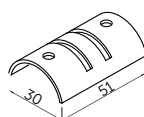
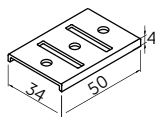

MT-5130A 600 22g

MT-5130B 600 22g

MT-5138 L 20 988g

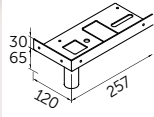

MT-5138 R

20
988g

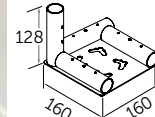

MT-5139 L

12
1,268g

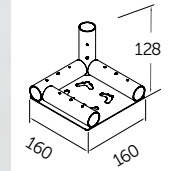

MT-5139 R

12
1,268g

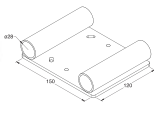

MT-5139 C

12
1,080g

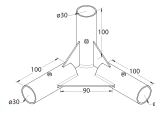

MT-5142

10
200g

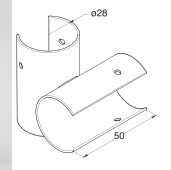

MT-5160I

100
125g

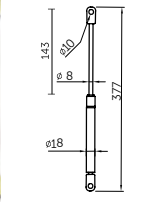

Capacidad: 15, 30 y 50 kg

MT-514315 • MT-514330 • MT-514350
Caja con 100 pzs • Peso x pza: 245 g

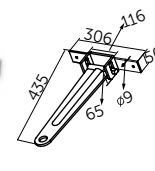

MT-5144A

1
4,500g

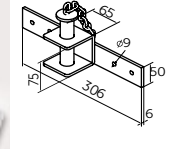

MT-5145A

1
3,500g

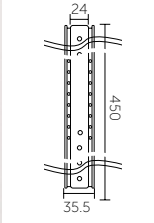

MT-5147

1
654g

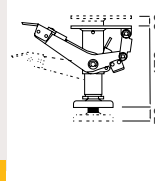

RUEDAS DE 4" Y 5"

MT-5148A

20
1,206g

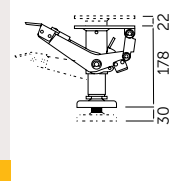

RUEDAS DE 6"

MT-5148B

8
2,802g

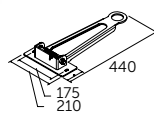

MT-5149A

5
2,158g

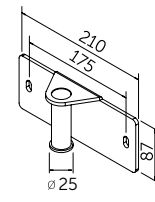

MT-5149B

20
1,080g

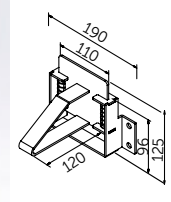

MT-5151

10
1,268g

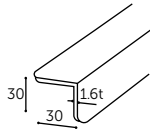

MT-5211

3m / barra
 △ 2,250g

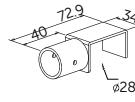

MT-5301

120
 △ 140g

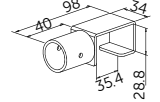

MT-5302

90
 △ 169g

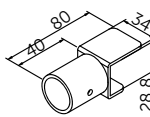

MT-5303

120
 △ 140g

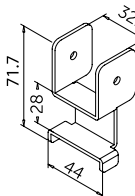

MT-5311

120
 △ 70g

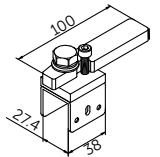

MT-5320

80
 △ 264g

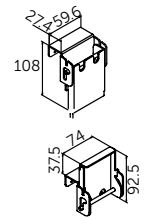
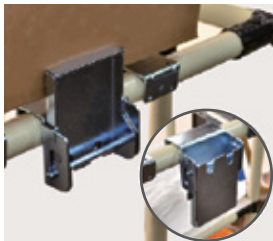

MT-5321

20
 △ 355g

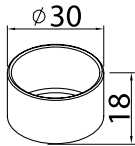
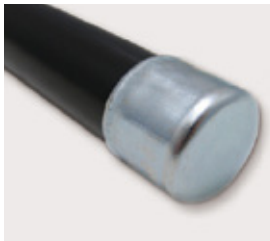

SC-3028SV

400
 △ 22g



K01RD

Herramienta para
 rebear tubos

CÓDIGO PESO X PIEZA A B

CÓDIGO	PESO X PIEZA	A	B
WG-0230	190 g	230mm	70mm
WG-0330	240 g	330mm	
WG-0430	280 g	430mm	

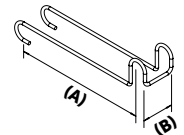
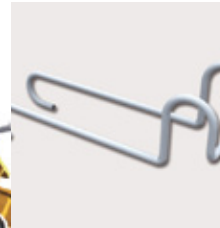

SISTEMA DE TRACCIÓN LEAN

ME-1001

△ 3,750g

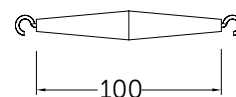
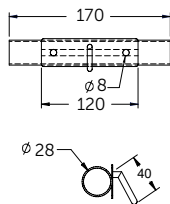
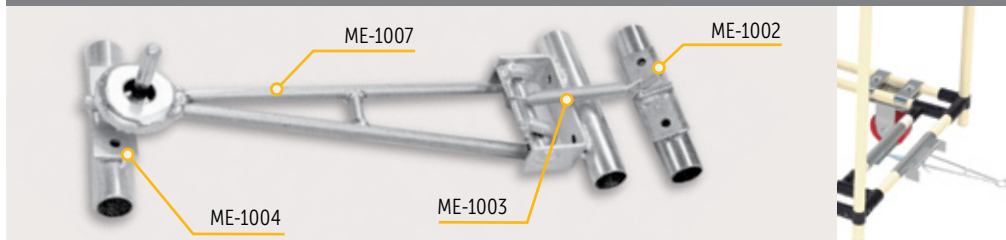

ME-1002

△ 39 g

ME-1003

△ 6 g

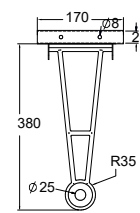
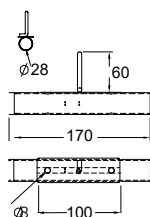

ME-1004

△ 37 g

ME-1007

△ 1,710 g

SUPERFICIES



MELAMINA



ACRÍLICO

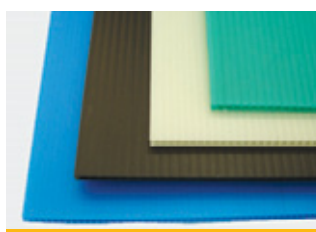

120 X 240 X 4mm

COROPLAST

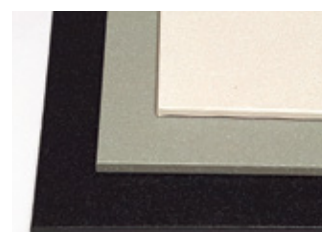

HDPE



MDF



CALIBRES: 12, 14, 16, 18, 20 Y 21

LÁMINA DE ACERO

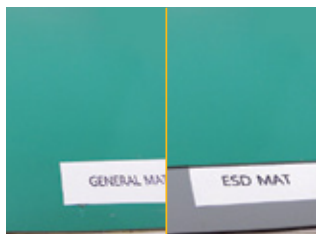

CUBIERTA AUTOADHERIBLE

CÓDIGO	ANCHO	COLOR
GM-120030	120 cm	Verde
⚡ EM-060010	60 cm	Verde ESD
⚡ EM-060013	60 cm	Gris ESD
⚡ EM-120010	120 cm	Verde ESD
⚡ EM-120013	120 cm	Gris ESD

PATAS, AJUSTADORES E INSERTOS

AC-3829RB 📦 500
⚖️ 26g

AD-3012SS 📦 150
⚖️ 80g

AD-3012SL 📦 100
⚖️ 110g

AD-3012SX 📦 50
⚖️ 164g

AD-5012LS 📦 150
⚖️ 95g

AD-5012LL 📦 500
⚖️ 26g

AD-5012LX 📦 50
⚖️ 164g

AS-3050MP 📦 100
⚖️ 36g

AS-5030P 📦 100
⚖️ 105g

AS-5050MS 📦 100
⚖️ 68g

CN-3010MS 📦 400
⚖️ 24g

CN-3010MP 📦 300
⚖️ 14g

MT-5133R 📦 400
⚖️ 8g

MT-5134P 📦 200
⚖️ 52g

TL-4000 📦 50
⚖️ 130g

INSERTOS

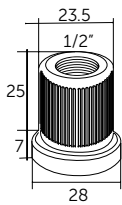

MT-5136

300
88g

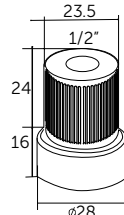

MT-5136P

200
15g

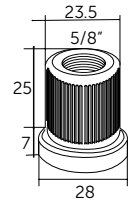

MT-5137

300
88g

INSERTOS PARA AJUSTADOR

	CÓDIGO	TUBO	TIPO DE TUBO
	MT-5136	1.0 mm	Estándar
	MT-5136T2	2.0 mm	Estándar
	MT-5136ST07	0.7 mm	Estándar / Acero Inox
	MT-5136ST11	1.1 mm	Acero Inox

INSERTOS PARA RUEDA

	CÓDIGO	TUBO	TIPO DE TUBO
	MT-5137	1.0 mm	Estándar
	MT-5137T2	2.0 mm	Estándar
	MT-5137ST07	0.7 mm	Estándar / Acero Inox
	MT-5137ST11	1.1 mm	Acero Inox

CUBIERTAS PROTECTORAS PARA TUBOS



TH-0001

Cubierta Protectora Plástica Tramada

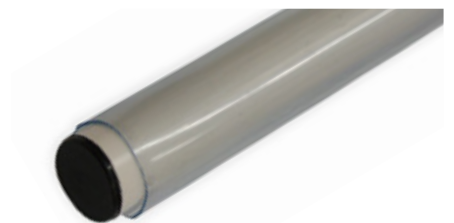

TH-0002

Cubierta Protectora Plástica Transparente

CÓDIGO	MATERIAL	LONGITUD
TH-0001	PVC	45 m / rollo
TH-0002	PVC	45 m / rollo
TH-0003	Atilon	4 m / pieza
TH-0005	Hule Suave	2 m / pieza



TH-0003

Cubierta Protectora Atilon



TH-0005

Cubierta Protectora de Hule Espuma EPDM

MICAS PROTECTORAS

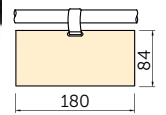
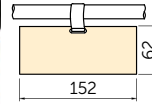
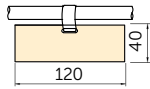

NP-0120

3,000
6g

NP-0150

2,500
13g

NP-0180

1,500
20g

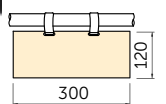
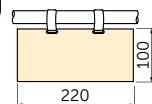
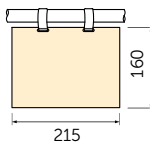

NP-0215

700
48g

NP-0220

1,000
28g

NP-0300

600
47g

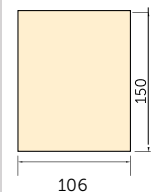
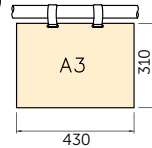
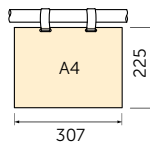

NP-0307

300
94g

NP-0430

100
170g

NPA-110

3,000
6g

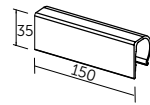

PN-3515

300
49g

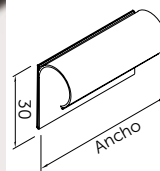

CÓDIGO	ALTO	ANCHO	🛒	📦
LH-3010CS	30	100 mm	12 g	500
LH-3015CS		150 mm	18 g	350
LH-3020CS		200 mm	24 g	300
LH-3030CS		300 mm	36 g	150

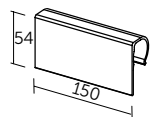

PN-5415

250
58g

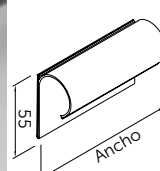
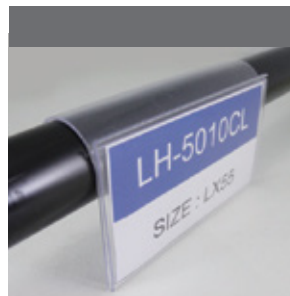

CÓDIGO	ALTO	ANCHO	🛒	📦
LH-5010CL	55	100 mm	22 g	400
LH-5015CL		150 mm	33 g	200
LH-5020CL		200 mm	44 g	200
LH-5030CL		300 mm	66 g	100

TORNILLERÍA

WB-0610/0625



• ZN • NI • BK

M6 x 10/25

BT-0835/40/45



M8 x 35/40/45

BT-0850/60/70



M8 x 50/60/70

BT-1020/25



M10 x 20/25

BT-1220/25



M12 x 20/25

BT-1250



1/2 x 50

NU-0600



• ZN • NI • BK

M6

NN-0800/1000/1200



M8

NU-1200



1/2

SC-0820/25/30/35



#8 x 19/25/30/35

SE-0810/20/25/30



#8 x 10/20/25/35

SW-0810/20/30



#8 x 10/20/30

SW-1020



#10 x 20

ME-1010



PARA ME-001: 6 pzas

ME-1010



PARA ME-001: 6 pzas

ROLLERS

Los rollers son un sistema lean de transporte que garantiza el flujo continuo de piezas. Utilizados principalmente en Flow Racks y Supermercados permiten el desplazamiento de contenedores o piezas por efecto de gravedad, lo que facilita su manejo y almacenamiento.

CÓDIGO	ESPECIFICACIÓN	MARCO	RUEDAS	ANCHO	ALTO	EJES	CAPACIDAD
PL-7001BK	Acero 36 mm	Acero (SPGI)	Negra Ø30	36 mm	34 mm	34.8 mm	200 kg/m
PL-7001WH	Acero 36 mm		Blanca Ø30	36 mm	34 mm	34.8 mm	200 kg/m
PL-3111	Acero 40 mm		Blanca Ø30	40 mm	42 mm	35.7 mm	220 kg/m
PL-3111BK	Acero 40 mm		Negra Ø30	40 mm	42 mm	35.7 mm	220 kg/m
⚡ PL-3111ED	Acero 40 mm (ESD)		Negra Ø30	40 mm	42 mm	35.7 mm	220 kg/m
PL-3111YL	Acero 40 mm		Amarilla Ø30	40 mm	42 mm	35.7 mm	220 kg/m
GP-4014WH	Acero 40 mm		Blanca Ø46	40 mm	50 mm	53.6 mm	220 kg/m
⚡ PL-6014ED	Acero 60 mm (ESD)		Negra Ø30	60 mm	34 mm	37 mm	300 kg/m
PL-6014WH	Acero 60 mm		Blanca Ø30	60 mm	34 mm	37 mm	300 kg/m
PL-6014WS	Acero 60 mm		Negra Ø16	60 mm	27 mm	18.5 mm	300 kg/m
⚡ PL-7314ED	Acero 73 mm (ESD)		Negra Ø34	73 mm	41 mm	40 mm	350 kg/m
PL-7314WH	Acero 73 mm		Blanca Ø34	73 mm	41 mm	40 mm	350 kg/m
PL-7314WS	Acero 73 mm		Blanca Ø18	73 mm	33 mm	20 mm	350 kg/m
PL-8500	Acero 85 mm		Blanca Ø34	85 mm	44 mm	25 mm	400 kg/m

ROLLER 36mm

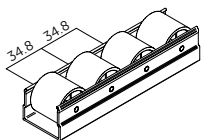
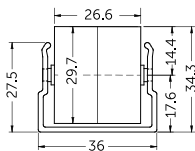

PL-7001BK Tramo de 4m • \triangle 1,180g



PL7001WT Tramo de 4m • \triangle 1,180g

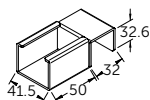

MT-7001A \triangle 120 \triangle 138g

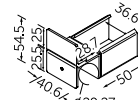
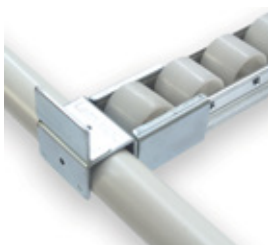

MT-7002B \triangle 120 \triangle 160g

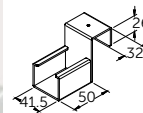
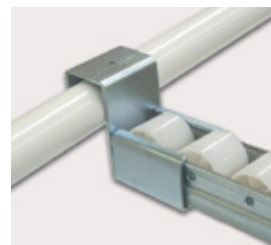

MT-7002BW \triangle 120 \triangle 140g

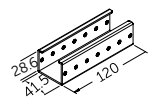

MT-7003C \triangle 120 \triangle 200g

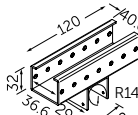

MT-7004D \triangle 120 \triangle 252g

ROLLER 40mm

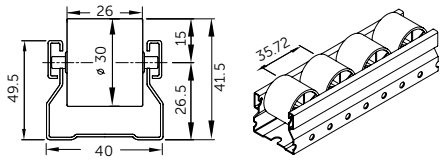

PL-3111 · PL-3111ED · PL-3114BK · PL-3111YL



PL-3111 Tramo de 4m • \triangle 1,125g



PL-3111BK Tramo de 4m • \triangle 1,248g

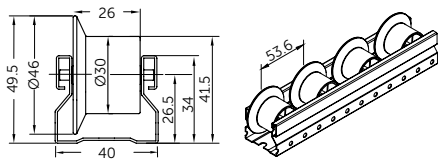

GP-4014WH



PL-3111ED Tramo de 4m • \triangle 1,180g



PL3111YL Tramo de 4m • \triangle 1,248g



GP-4014WH Tramo de 4m • \triangle 1,102g

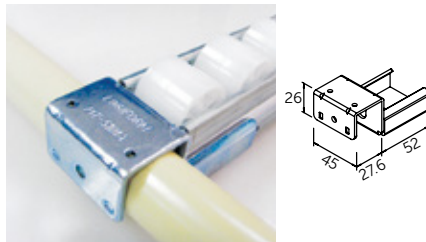

MT-5140A \triangle 80 130g

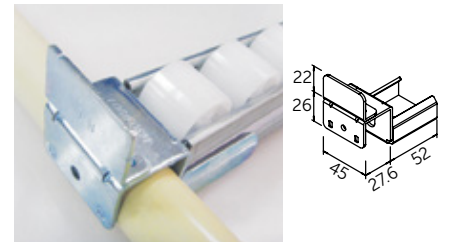

MT-5140B \triangle 60 167g

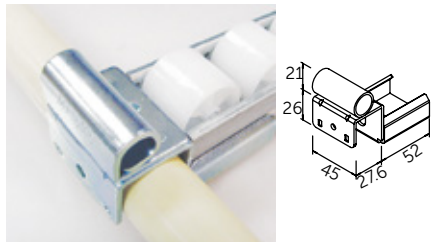

MT-5140BP \triangle 50 184g

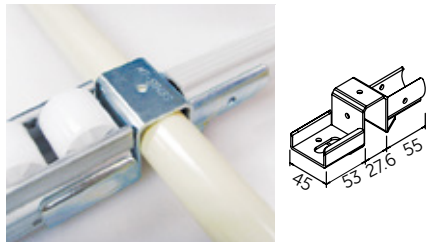

MT-5140BS \triangle 30 243g

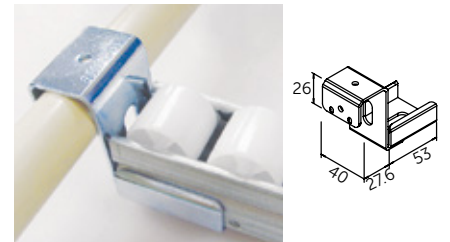

MT-5140BW \triangle 70 157g

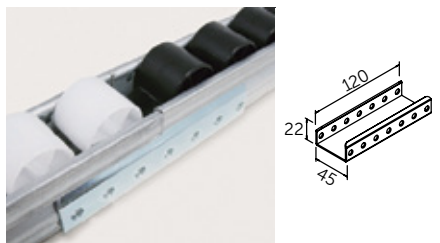

MT-5140C \triangle 100 125g

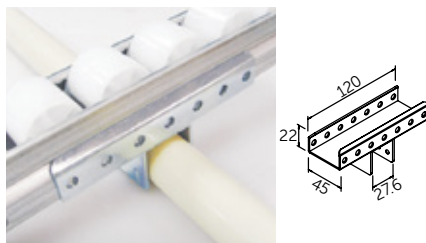

MT-5140D \triangle 40 190g

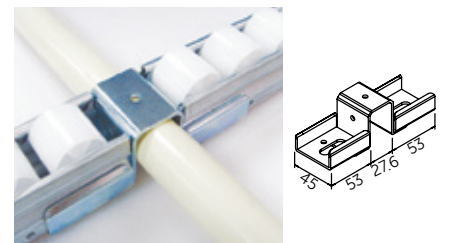

MT-5140DA \triangle 30 243g

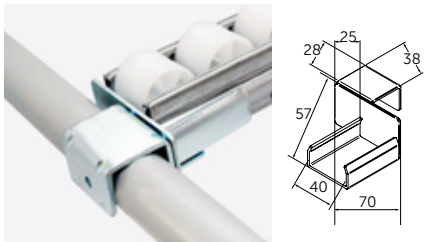

MT-PLAL

40
246g

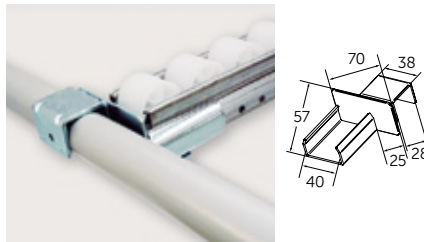

MT-PLAR

40
246g

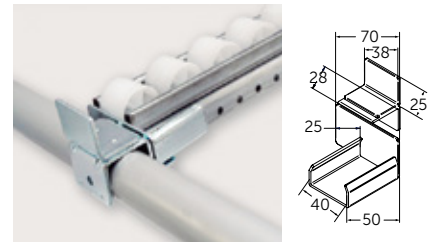

MT-PLBL

40
246g

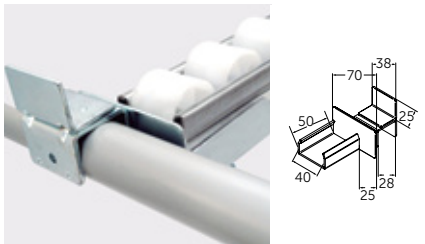

MT-PLBR

30
243g

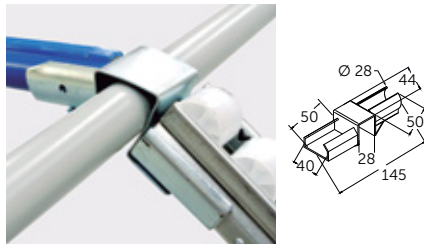

MT-PLHN

30
243g

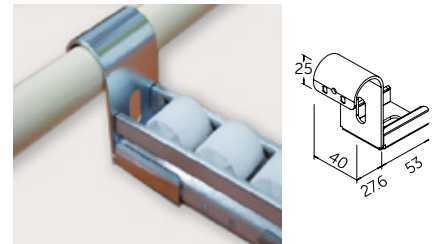

MT-4010BR

70
160g

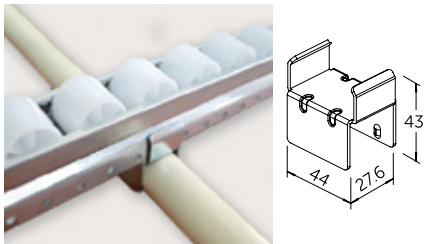

MT-4010E

49
180g

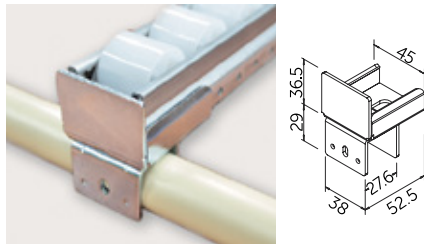

MT-4010X

80
150g

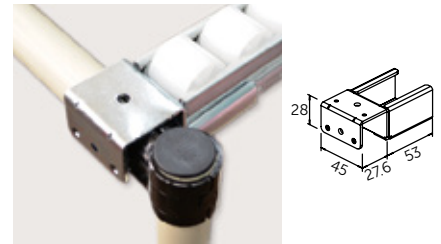

MT-4012A

60
163g

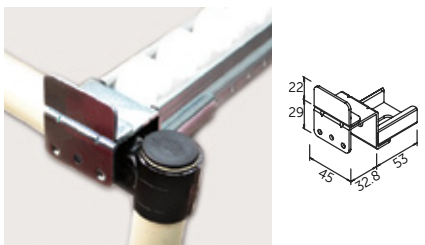

MT-4012B

40
195g

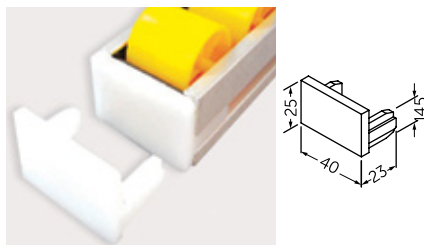

PJ-140AL

2,000
6g

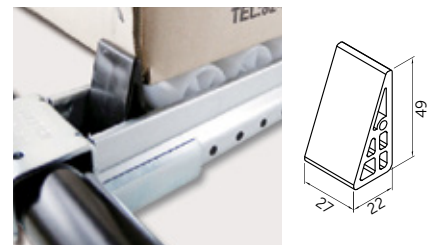

PJ-1401BK

1,000
12g

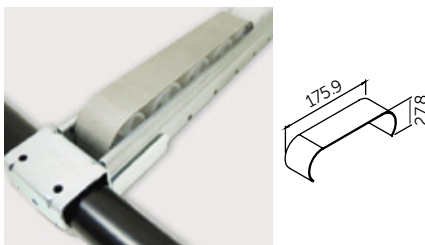

MS-4018SV

300
60g

ROLLER 60mm

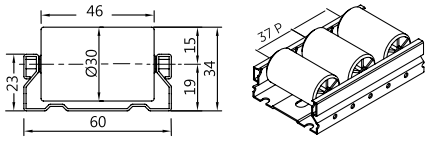

PL-6014WH · PL-6014ED



PL-6014WH Tramo de 4m • \triangle 1,250g



PL-6014ED Tramo de 4m • \triangle 1,298g

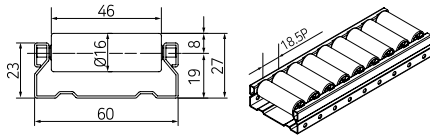

PL-6014WS



PL-6014WS Tramo de 4m • \triangle 1,293g

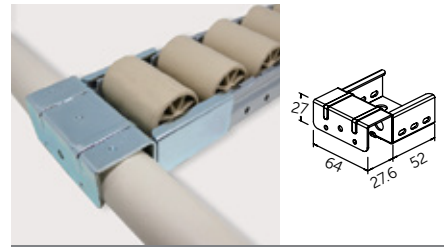

MT-5060A \triangle 60 138g

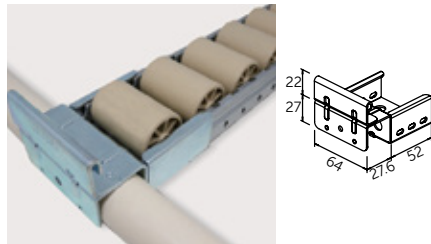

MT-5060B \triangle 50 176g

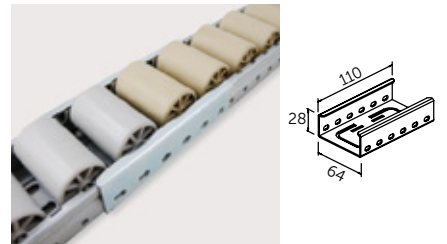

MT-5060C \triangle 60 163g

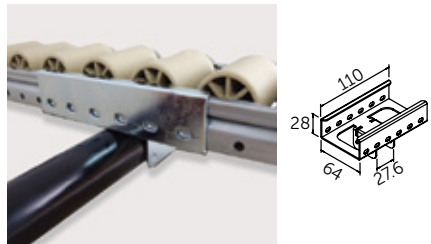

MT-5060D \triangle 30 207g

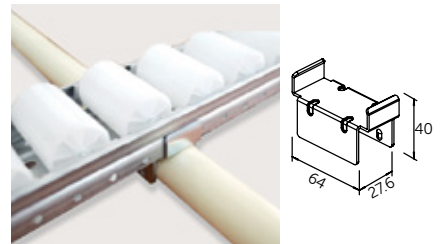

MT-6010E \triangle 120 64g

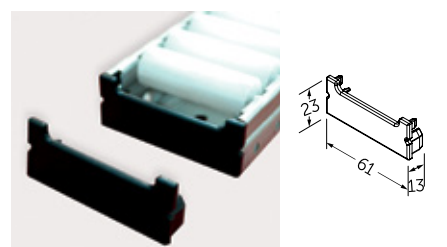

PJ-160ST \triangle 2,000 3.5g

ROLLER 73mm

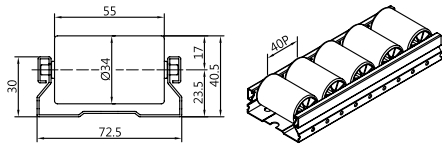

PL-7314ED



PL-7314ED

Tramo de 4m • \triangle 1,910g



PL-7314WS

Tramo de 4m • \triangle 1,910g

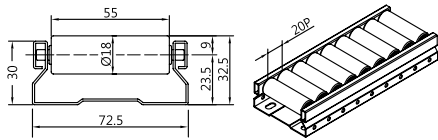

PL-7314WS



MT-5073A

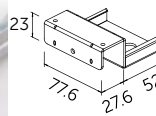

\triangle 40
198g



MT-5073B

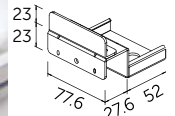

\triangle 30
250g

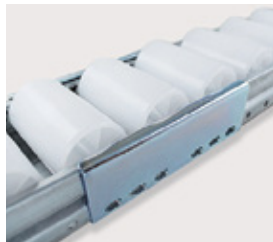

MT-5073C

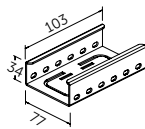

\triangle 40
204g



MT-5073E

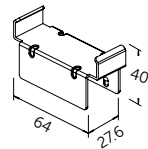

\triangle 100
76g

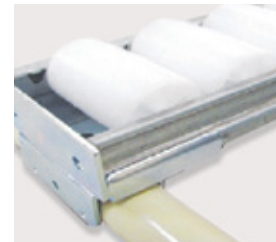

MT-5073X

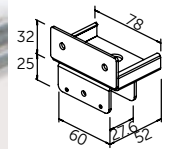

\triangle 50
210g



MT-7312A

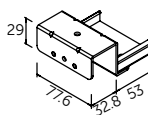

\triangle 40
273g



MT-7312B

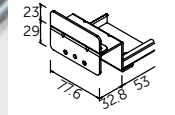

Caja con 30 pzs
Peso x pza: 360g



PJ-173AL

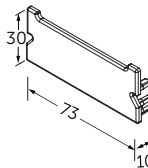

\triangle 1,300
6g



MS-7318SV

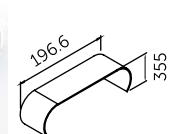

\triangle 100
126g

ROLLER 85mm

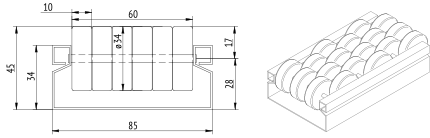

PL-8500



PL-8500 Tramo de 4m • \triangle 1,800g



MT-8500A \triangle 70
 \triangle 18g



MT-8500B \triangle 50
 \triangle 20g



MT-8500BW \triangle 80
 \triangle 19g

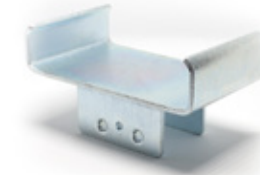

MT-8500D \triangle 80
 \triangle 16g

MONTURAS TUBO SLIDE



MT-8500DA \triangle 34
 \triangle 30g

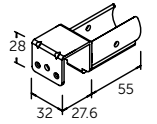

MT-5160A \triangle 100
 \triangle 122g

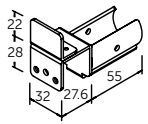

MT-5160B \triangle 80
 \triangle 145g

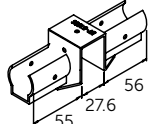

MT-5160C \triangle 30
 \triangle 240g

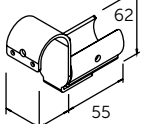

MT-5160D \triangle 80
 \triangle 138g

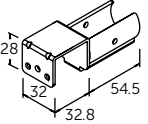

MT-5160E \triangle 100
 \triangle 120g

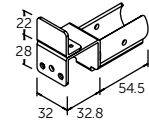

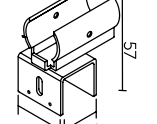

MT-5160F \triangle 80
 \triangle 148g





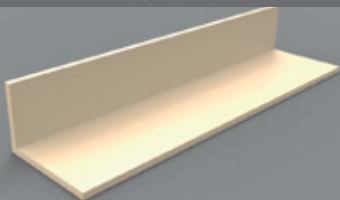
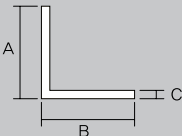
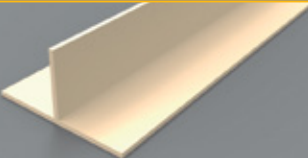
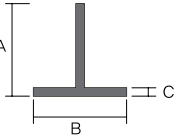

MT-5160G \triangle 90
 \triangle 132g

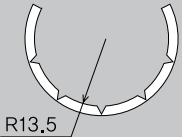
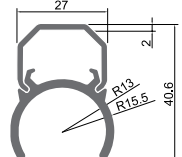
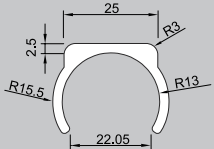
ÁNGULOS Y GUÍAS

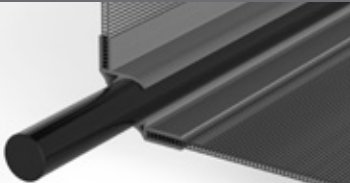
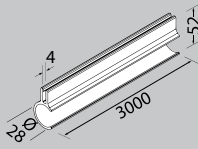
ÁNGULOS	TIPO	TAMAÑO	CÓDIGO	A	B	C	PESO	CANTIDAD
	"L"		PA-2501	30	50	T3	340 g/m	10 x atado
			PA-2502	80	90		723 g/m	
			PA-2503	50	50		586 g/m	
			PA-2503A	50	75	T4	706 g/m	
			PA-2504	50	100		833 g/m	
			PA-2505	50	150		1,180 g/m	
			PA-2505A	50	200		1,430 g/m	
	"T"		PA-2506	50	100	T3	793 g/m	
			PA-2506A	150	50	T4	1,121 g/m	
			PA-2507	100	60	T5	1,106 g/m	

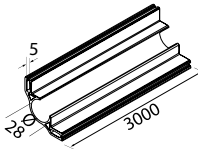
CUBIERTAS	TIPO	TAMAÑO	CÓDIGO	ESPESOR	PESO
	"C"		PA-2509 ● IV ● GR	T3	223 g/m
 Ducto de cables	"B"		① CD-3000T	-	158 g/m
			② CD-3000B		282 g/m
 Cubierta plana	-		PA-4028B ● IV ● GR ● BK	T2.5	280 g/m

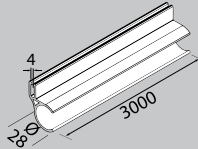
GUÍAS	TIPO	TAMAÑO	CÓDIGO	PESO	CANTIDAD
	"T"		SG-01	45 g/m	8x atado
	"C"		SG-02	740 g/m	10x atado
	"L"		SG-03	490 g/m	10x atado

GUÍAS PARA ROLLER

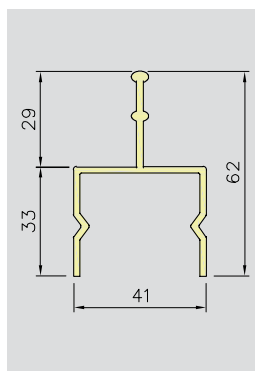
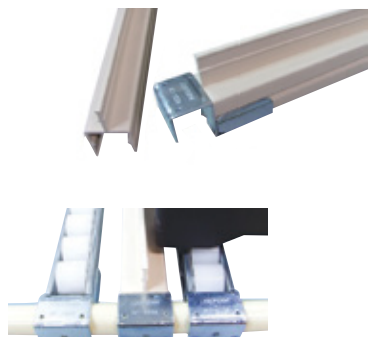

PA-240A

Para Roller PL-3111

Atados de 10
Peso: 619 g/m
Longitud: 3m

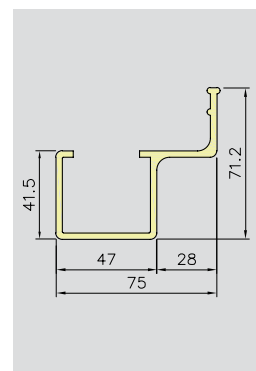
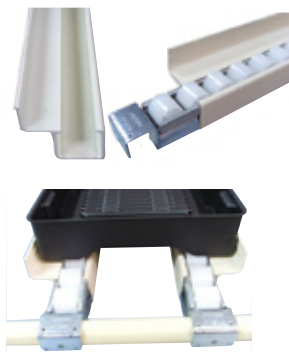

PA-240B

Para Roller PL-3111

Atados de 10
Peso: 740 g/m
Longitud: 3m

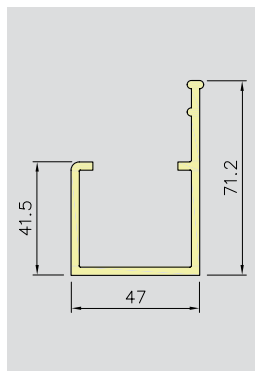
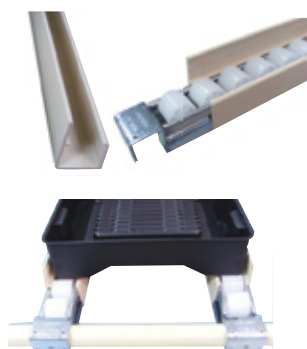

PA-240C

Para Roller PL-3111

Atados de 10
Peso: 640 g/m
Longitud: 3m

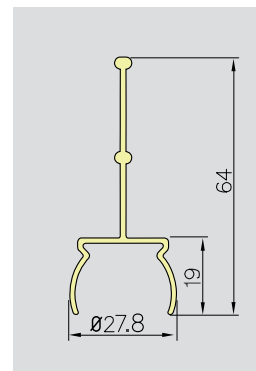
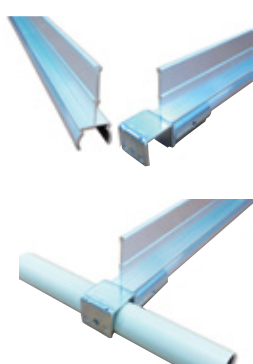

PA-240E

Para Roller PL-3111

Atados de 10
Peso: 1,688 g/m
Longitud: 4m

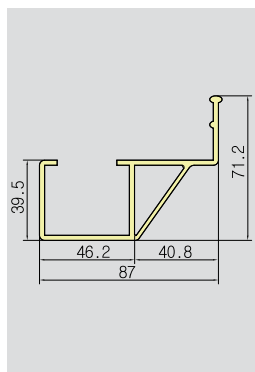

PA-412B

Para Roller PL-3111

Atados de 10
Peso: 906 g/m
Longitud: 3m

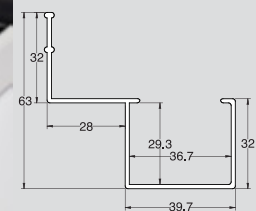
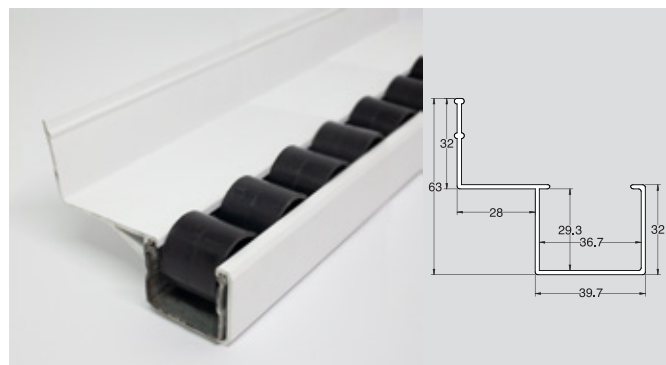

PA-7001B

Para Roller PL-7001

Atados de 10
Peso: 906 g/m
Longitud: 3m

RODAMIENTOS

Si requiere que su estructura sea móvil, puede escoger entre varios tipos de ruedas dependiendo de las condiciones de piso, carga y presupuesto.

Carga práctica = Capacidad de carga de una rueda x número de ruedas utilizadas x 0.33

La carga práctica corresponde a la carga total que podrá colocar en su Estructura Lean. Tiene un factor de seguridad del 33% para incluir el peso del rack o estructura.

RUEDA CON TORNILLO CARGA MÁXIMA DE 105 KG



RUEDA CON PLACA CARGAS MAYORES A 100 KG

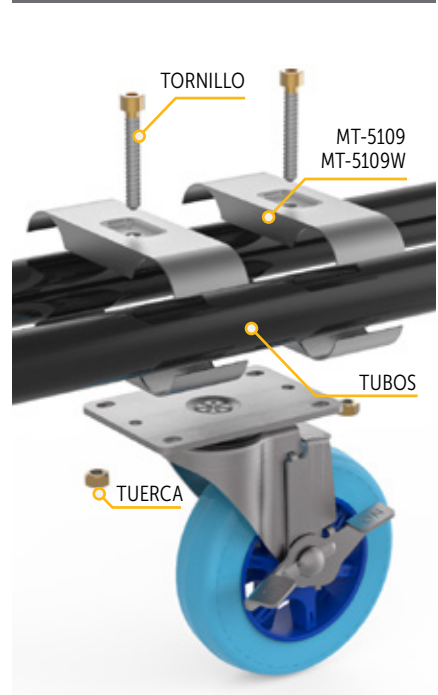









CON TORNILLO PARA CARGAS LIVIANAS















ARTÍCULO	CÓDIGO DEL PRODUCTO	TIPO	pulgadas (mm)	pulgadas	pulgadas (mm)	mm	kg (max)	RUEDA	PESO kg	CANTIDAD POR CAJA	
	CT-702S	GIRATORIA	2"	1/2	20	44	72	POLIURETANO	0.16	160	
	CT-703S		3"	5/8	32	73	108		0.69	32	
	CT-704S		4"	5/8	32	89	133		105	0.79	24
	CT-702B	GIRATORIA CON FRENO	2"	1/2	20	44	72		0.16	160	
	CT-703B		3"	5/8	32	73	108		0.75	32	
	CT-704B		4"	5/8	32	89	133		105	0.89	24
	CT-703SE	GIRATORIA	3"	5/8	32	73	108		0.69	32	
	CT-704SE		4"	5/8		89	133		105	0.79	24
	CT-703BE	GIRATORIA CON FRENO	3"	5/8		73	108		100	0.75	32
	CT-704BE		4"	5/8		89	133		105	0.89	24

ANTIESTÁTICO/ ESD











CON EXPANSOR

ARTÍCULO	CÓDIGO DEL PRODUCTO	TIPO	 pulgadas (mm)	 pulgadas	 pulgadas (mm)	 mm	 mm	 kg (max)	RUEDA	PESO kg	CANTIDAD POR CAJA
	CT-703EX	GIRATORIA	3"	1 1/4"	32	73	108	90	ALTO POLIURETANO	0.90	20
	CT-704SEX		4"			89	133	124			
	CT-703BEX	GIRATORIA CON FRENO	3"			73	108	90			
	CT-704BEX		4"			89	133	124			









CON PLACA PARA CARGAS LIVIANAS

ARTÍCULO	CÓDIGO DEL PRODUCTO	TIPO	 pulgadas (mm)	 pulgadas (mm)	 mm	 mm	 mm	 kg (max)	 mm	 mm	RUEDA	PESO kg	CANTIDAD POR CAJA
	CT-713RL	RÍGIDA	3"	32	NA	104	100	95 x 64	76 a 73 x 45		POLIURETANO	0.54	32
	CT-714RL		4"			129	105					0.83	24
	CT-715RL		5"			156	115					0.74	20
	CT-713SL	GIRATORIA	3"		73	104	100					0.83	32
	CT-714SL		4"		89	129	105					0.94	24
	CT-715SL		5"		101	156	115					1.03	20
	CT-713BL	GIRATORIA CON FRENO	3"		73	104	100					0.88	32
	CT-714BL		4"		89	129	105					1.03	24
	CT-715BL		5"		101	156	115					1.12	20
	CT-713RE	RÍGIDA	3"		104	56	GOMA SUAVE (ESD)				0.58	32	
	CT-714RE		4"		NA	129					75	0.88	24
	CT-715RE		5"		156	80					1.17	20	
	CT-713SE	GIRATORIA	3"	73	104	56		0.87	32				
	CT-714SE		4"	89	129	75		1.05	24				
	CT-715SE		5"	101	156	80		1.24	20				
	CT-713BE	GIRATORIA CON FRENO	3"	73	104	56		0.93	32				
	CT-714BE		4"	89	129	75		1.32	24				
	CT-715BE		5"	101	156	80		1.72	20				











CON PLACA PARA CARGAS MEDIANAS

ARTÍCULO	CÓDIGO DEL PRODUCTO	TIPO	 pulgadas (mm)	 pulgadas (mm)	 mm	 mm	 kg (max)	 mm	 mm	RUEDA	PESO kg	CANTIDAD POR CAJA						
	CT-714RH	RÍGIDA	4"	38		137	200	114 x 102	92 a 76 x 76 a 66	POLIURETANO	1.72	10						
	CT-715RH		5"	40	NA	165	250				2.15	10						
	CT-716RH		6"	44		190	270				2.63	8						
	CT-714SH	GIRATORIA	4"	38	82	137	200				114 x 102	92 a 76 x 76 a 66	POLIURETANO	1.85	10			
	CT-715SH		5"	40	90	165	250							2.58	10			
	CT-716SH		6"	44	108	190	270							2.94	8			
	CT-714BH	GIRATORIA CON FRENO	4"	38	82	137	200							114 x 102	92 a 76 x 76 a 66	POLIURETANO	1.85	10
	CT-715BH		5"	40	90	165	250										2.77	10
	CT-716BH		6"	44	108	190	270										3.14	8











CON TORNILLO DE ALTO POLIURETANO CUARTO LIMPIO

ARTÍCULO	CÓDIGO DEL PRODUCTO	TIPO	 pulgadas (mm)	 pulgadas	 pulgadas (mm)	 mm	 mm	 kg (max)	RUEDA	PESO kg	CANTIDAD POR CAJA			
	CT-703SP	GIRATORIA	3"	5/8	32	78	104	56	ALTO POLIURETANO	0.62	32			
	CT-704SP		4"			89	129	75		0.75	24			
	CT-705SP		5"			101	156	80		0.88	20			
	CT-703BP	GIRATORIA CON FRENO	3"			5/8	32	78		104	56	ALTO POLIURETANO	0.68	32
	CT-704BP		4"					89		129	75		0.84	24
	CT-705BP		5"					101		156	80		0.96	20









CON PLACA DE ALTO POLIURETANO CUARTO LIMPIO

ARTÍCULO	CÓDIGO DEL PRODUCTO	TIPO	 pulgadas (mm)	 pulgadas (mm)	 mm	 mm	 kg (max)	 mm	 mm	RUEDA	PESO kg	CANTIDAD POR CAJA											
	CT-713RP	RÍGIDA	3"	32	NA	104	56	95 x 64	76 a 73 x 45	ALTO POLIURETANO	0.45	32											
	CT-714RP		4"			129	75				0.55	24											
	CT-715RP		5"			156	80				0.66	20											
	CT-713SP	GIRATORIA	3"			32	NA				78	104	95 x 64	76 a 73 x 45	ALTO POLIURETANO	0.74	32						
	CT-714SP		4"								89	129				75	0.84	24					
	CT-715SP		5"								101	156				80	0.97	20					
	CT-713BP	GIRATORIA CON FRENO	3"								32	NA				78	104	95 x 64	76 a 73 x 45	ALTO POLIURETANO	0.80	32	
	CT-714BP		4"													89	129				75	0.93	24
	CT-715BP		5"													101	156				80	1.06	20

CON PLACA CON AMORTIGUAMIENTO

ARTÍCULO	CÓDIGO DEL PRODUCTO	TIPO	 pulgadas (mm)	 pulgadas (mm)	 mm	 mm	 kg (max)	 mm	 mm	RUEDA	PESO kg	CANTIDAD POR CAJA
	CT-726RC	RIGIDA	6"								5.146	4
	CT-726SC	GIRATORIA	6"	48	128	203	360	160 x 115	129 x 72.5	POLIURETANO	5.876	
	CT-726BC	GIRATORIA CON FRENO	6"								6.178	

CON ANILLO DE AGARRE

ARTÍCULO	CÓDIGO DEL PRODUCTO	TIPO	 pulgadas (mm)	 pulgadas (mm)	 mm	 mm	 kg (max)	ENROSCADO	RUEDA	PESO kg	CANTIDAD POR CAJA
	CT-703RR	RIGIDA	3"							0.44	40
	CT-703SR	GIRATORIA	3"	32	70	100	75	Ø11 X 38mm	POLIURETANO	0.5	
	CT-703BR	GIRATORIA CON FRENO	3"							0.56	

INSERTOS PARA RUEDAS CON ANILLO DE AGARRE

			CI-1109SP	Peso x pza: 22.6 g
			CI-1111SP	Peso x pza: 22.6 g
			CI-1110LP	Peso x pza: 22.6 g

GAVETAS

Las gavetas maximizan la capacidad de almacenaje y organizan el centro de trabajo. Facilitan la clasificación en colores y tamaños, resistentes a la corrosión, de fácil limpieza y acceso, resistentes a descargas eléctricas menores a 200 W.



CÓDIGO	LARGO	ANCHO	ALTO
51001	14.0 cm	10.5 cm	7.6 cm
51002	17.0 cm	10.5 cm	7.6 cm
51003	18.5 cm	11.8 cm	7.6 cm
51004	23.0 cm	14.5 cm	13.5 cm
51005	27.5 cm	16.5 cm	12.5 cm
51006	27.6 cm	21.0 cm	17.5 cm
51007	37.7 cm	23.5 cm	17.8 cm
51008	30.2 cm	20.0 cm	15.7 cm
51009	50.0 cm	30.9 cm	20.0 cm
51010	37.0 cm	41.5 cm	17.7 cm
51011	37.0 cm	12.0 cm	8.5 cm
51012	60.4 cm	12.0 cm	8.5 cm
51013	59.5 cm	28.0 cm	10.5 cm
51073	43 cm	26.0 cm	18.5 cm

Los colores de las gavetas y los contenedores se encuentran sujetos a disponibilidad. Verificar disponibilidad en:



CONTENEDORES



Útil en la logística de todo tipo de industria y maquilas.
 Capacidad de carga: 15 kg.
 Apilable.
 Tapadera (opcional)
Largo: 50.0 cm · Ancho: 34.0 cm
Altura: 26.0 cm

510014



CAJA QUEBEC



Disponibles con soporte para etiquetas.
 Útil para los procesos de armado en las cadenas de producción donde se requiere la utilización de diferentes componentes. Fácil de trasladar y/o almacenar.
 Capacidad de carga: 15 kg · Apilable.
Largo: 38.0 cm · Ancho: 24.0 cm
Altura: 10.5 cm

510015



CAJA INDUSTRIAL NO.1



Capacidad de carga: 10 kg.
 Apilable.
Largo: 48.0 cm
Ancho: 38.0 cm
Altura: 10.5 cm

510016



CAJA INDUSTRIAL NO.2



Capacidad de carga: 25 kg.
 Apilable.
Largo: 48.0 cm
Ancho: 38.0 cm
Altura: 20.0 cm

510017



CAJA INDUSTRIAL NO.3



Capacidad de carga: 25 kg.
 Apilable.
 Tapadera (opcional)
Largo: 76.8 cm
Ancho: 48.0 cm
Altura: 20.7 cm

510018



CAJA INDUSTRIAL NO.4



Útil en la logística de todo tipo de industria y maquilas.
 Capacidad de carga: 10 kg.
 Apilable con tapa y anidable con la tapa abierta.
Largo: 50.0 cm
Ancho: 30.0 cm
Altura: 21.0 cm

510021



CAJA CANADA CON TAPA



Cierre de tapa con bisagras ayudando a que se maneje junto con la caja. Útil en la logística de todo tipo de industria y maquilas.
 Capacidad de carga: 30 kg
 Apilable y Anidable
Largo: 50.0 cm
Ancho: 30.0 cm
Altura: 21.0 cm

510022



CAJA DE BISAGRA 50-21 CON TAPA



Cierre de tapa con bisagras ayudando que la misma se maneje junto con la caja. Útil en la logística de todo tipo de industria y maquilas.
 Capacidad de carga: 30 kg
 Apilable y Anidable
Largo: 60.0 cm
Ancho: 40.0 cm
Altura: 32.0 cm

510023



CAJA DE BISAGRA 60-32 CON TAPA



Capacidad de carga: 60 kg.
 Apilable y Anidable.
Largo: 78.0 cm
Ancho: 45.0 cm
Altura: 35.0 cm

510024



CAJA ENFILABLE CALADA C/ASA



Capacidad de carga: 70 kg.
 Apilable y Anidable.
Largo: 78.0 cm
Ancho: 44.0 cm
Altura: 35.0 cm

510025



CAJA ENFILABLE CERRADA C/ASA



Capacidad de carga: 30 kg.
Apilable y Anidable.
Piso liso con o sin desagüe.
Tapadera (opcional).

Largo: 60.0 cm
Ancho: 40.0 cm
Altura: 28.0 cm

510026

○ ● CAJA MONTREAL CALADA 28



Permite su amarre en la estiba, 2 ojillos en tapa y cesta para cinto de seguridad. Útil en el transporte y almacenaje, protege y evita el maltrato y faltantes de productos.

Piso liso con o sin desagüe · Capacidad de carga: 35 kg · Apilable y Anidable Tapadera (opcional).

Largo: 60.0 cm · Ancho: 40.0 cm
Altura: 28.0 cm

510027

○ ○ ○ CAJA MONTREAL CERRADA 28 CON TAPA



Permite su amarre en la estiba, 2 ojillos en tapa y cesta para cinto de seguridad. Útil en el transporte y almacenaje, protege y evita el maltrato y faltantes de productos.

Piso liso con o sin desagüe · Capacidad de carga: 25 kg · Apilable y Anidable Tapadera (opcional).

Largo: 60.0 cm · Ancho: 40.0 cm
Altura: 20.0 cm

510028

○ ○ CAJA MONTREAL DE 20 CON TAPA



Piso reforzado con o sin desagüe

Capacidad de carga: 25 kg

Apilable con las asas metálicas, anidable bajando las asas.

Largo: 62.5 cm
Ancho: 42.0 cm
Altura: 20.0 cm

510029

○ ○ CAJA OTAWA ENFILABLE DE 20



Piso reforzado con o sin desagüe

Capacidad de carga: 30 kg

Apilable con las asas metálicas, anidable bajando las asas.

Largo: 62.5 cm
Ancho: 42.0 cm
Altura: 28.0 cm

510030

○ CAJA OTAWA ENFILABLE DE 28



Piso reforzado con o sin desagüe

Capacidad de carga: 35 kg

Apilable con las asas metálicas, anidable bajando las asas.

Tapadera (opcional).

Largo: 60.0 cm
Ancho: 40.0 cm
Altura: 28.0 cm

510032

○ ○ ○ CAJA TORONTO CERRADA CON TAPA



Útil en la logística de almacenaje de cualquier tipo de producto, aprovechando al máximo el espacio en los procesos de producción al pie de máquina y en el traslado de sus productos a las diferentes áreas.

Capacidad de carga: 250 kg

Ruedas y/o tapadera (opcionales).

Largo: 80.0 cm · Ancho: 80.0 cm
Altura: 60.0 cm

510033

○ CONT. MÉX. MED. CERRADO CALADO



Útil en la logística de almacenaje de cualquier tipo de producto aprovechando al máximo el espacio en los procesos de producción al pie de máquina y en el traslado de sus productos a las diferentes áreas.

Capacidad de carga: 300 kg

Largo: 80.0 cm
Ancho: 80.0 cm
Altura: 80.0 cm

510034

○ ○ ○ CONTENEDOR MÉXICO CERRADO



Capacidad de carga: 200 kg

Apilable.

Largo: 83.0 cm
Ancho: 60.0 cm
Altura: 58.0 cm

510035

○ ○ CONTENEDOR MILANO CALADO



Útil en la logística de almacenaje de cualquier tipo de producto aprovechando al máximo el espacio en los procesos de producción al pie de máquina y en el traslado de sus productos a las diferentes áreas.

Capacidad de carga: 250 kg

Largo: 80.0 cm
Ancho: 80.0 cm
Altura: 80.0 cm

510036

○ ○ CONTENEDOR MÉXICO CALADO

BASE PARA CARRO "Z"

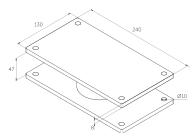
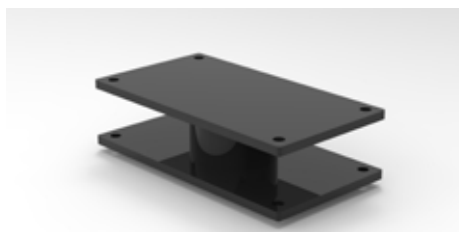

PB-240

2
4.9kg

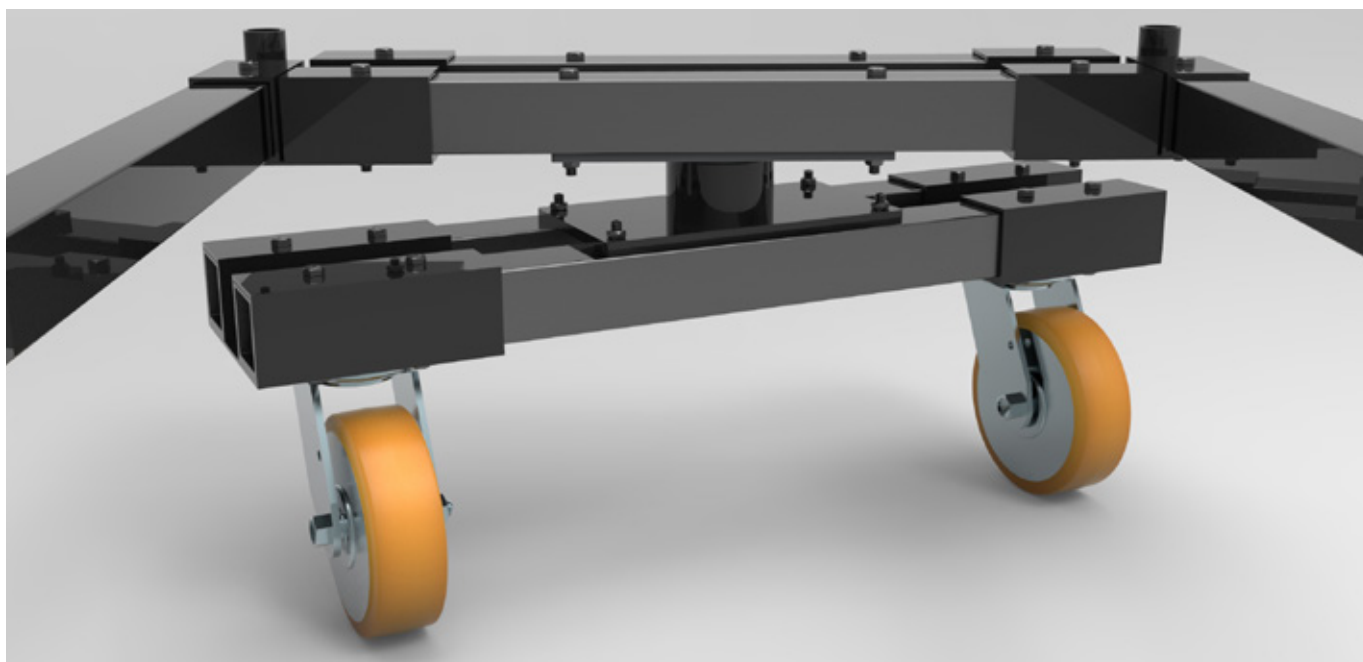

TUBOS

CÁLCULO DEL TAMAÑO DEL CORTE DE LOS TUBOS

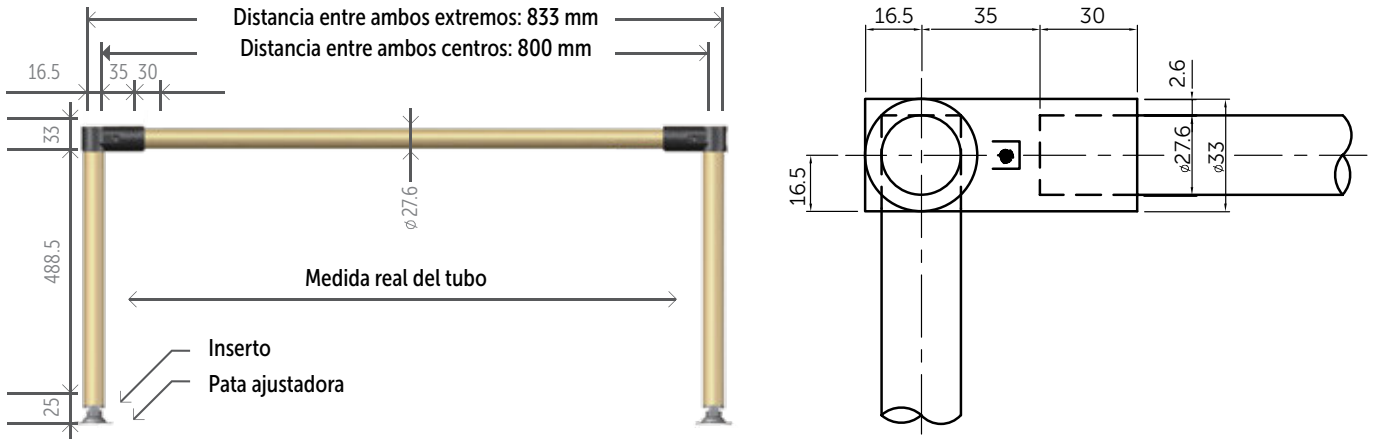

	Cálculo de longitudes horizontales	$\frac{800}{-70}$ 730 mm	Distancia entre ambos centros Distancia total en exteriores del tubo y centros de uniones (35mm x 2) Medida sugerida del tubo para ser cortado
	Cálculo de longitudes verticales	$\frac{530}{-25}$ $\frac{+17}{522}$ 522 mm	Distancia entre ambos centros Distancia (espacio) entre el extremo del tubo y el extremo de la pata Distancia entre el centro y la superficie de la unión Medida sugerida del tubo para ser cortado

LIMITES DE TEMPERATURA

La temperatura de uso sugerida para los tubos con resina ABS y uniones de acero es de: -10° C a 80° C, evite exponer a temperaturas fuera de estos límites o cerca del fuego.

UNIONES

Máxima fuerza de resistencia en los tubos atados con las uniones de metal.

PRUEBA

Velocidad: 5 mm/min
Temperatura: 23 °C

DIRECCIÓN	TUBO ABS	TUBO DE ACERO
X	75 KG	75 KG
Y	85 KG	85 KG

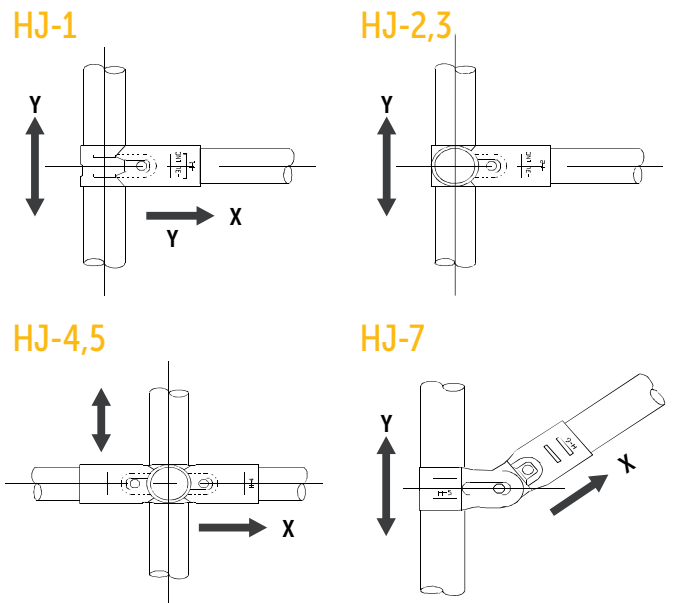

CARGA MÁXIMA ADMISIBLE PARA TUBOS

Condiciones de prueba

Velocidad de tensión: 5mm/min

Rango de Carga: 0~2,000kgf

Temperatura: 23 °C

Distancia entre apoyos: 450/1000/1500/1800 mm

Los datos fueron obtenidos en un ambiente controlado y pueden ser afectados por variaciones en el ambiente.



CÓDIGO	PRODUCTO	DISTANCIA ENTRE APOYOS			
		450 mm	1,000 mm	1,500 mm	1,800 mm
MP-1070	TUBO ABS STANDARD 0.7 mm	175.5	86.0	60.0	50.0
MP-1100	TUBO ABS STANDARD 1.0 mm	337.5	154.4	147.0	74.9
MP-1200	TUBO ABS STANDARD 2.0 mm	557.9	227.0	147.0	112.8
ST-1070 (SUS 201)	TUBO DE ACERO INOXIDABLE 0.7 mm	175.8	36.9	60.6	50.0
ST-1110 (SUS 201)	TUBO DE ACERO INOXIDABLE 1.1 mm	405.0	172.9	129.6	101.8
SL-1010	TUBO SLIDE 1.0 mm	377.1	162.9	109.2	83.2
AL-1102	TUBO DE ALUMINIO 1.1 mm	231.2	99.6	67.5	53.0

CARGA MÁXIMA ADMISIBLE PARA ROLLERS

POR TRAMO DEL ROLLER	ROLLER (ancho)	Ø	LONGITUD	CAP. DE CARGA
Condiciones de prueba Velocidad: 5mm/min Temperatura: 23° C 	36 mm	26 Ø	1,000 mm	80 kgf
	40 mm	30 Ø		100 kgf
	60 mm	30 Ø		115 kgf
	60 mm	16 Ø		105 kgf
	73 mm	34 Ø		215 kgf
	73 mm	18 Ø		225 kgf

COMPRESIÓN DE ROLLER	ROLLER (ancho)	Ø	CAP. DE CARGA
Condiciones de prueba Temperatura: 23° C 	36 mm	26 Ø	140 kgf
	40 mm	30 Ø	170 kgf
	60 mm	30 Ø	240 kgf
	60 mm	16 Ø	145 kgf
	73 mm	34 Ø	520 kgf
	73 mm	18 Ø	165 kgf

DESPIECE DE MATERIALES

Las siguientes figuras muestran el ensamble real de una Solución Lean y sus componentes.

CARRO 2 NIVELES

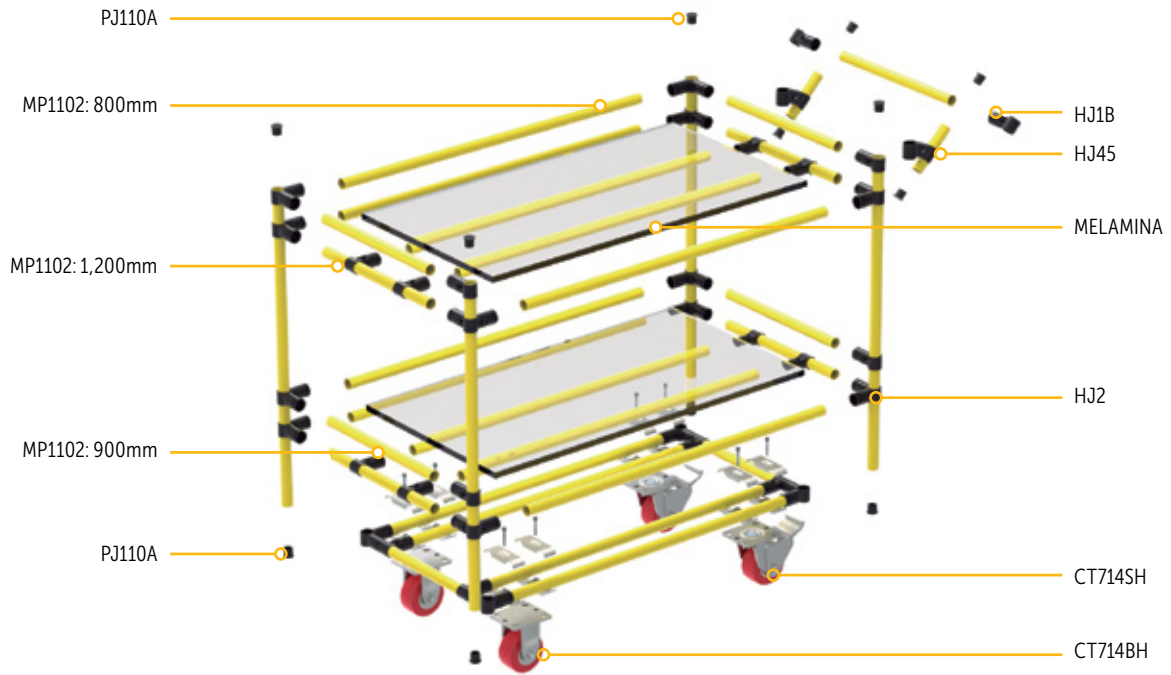

FLOW RACK

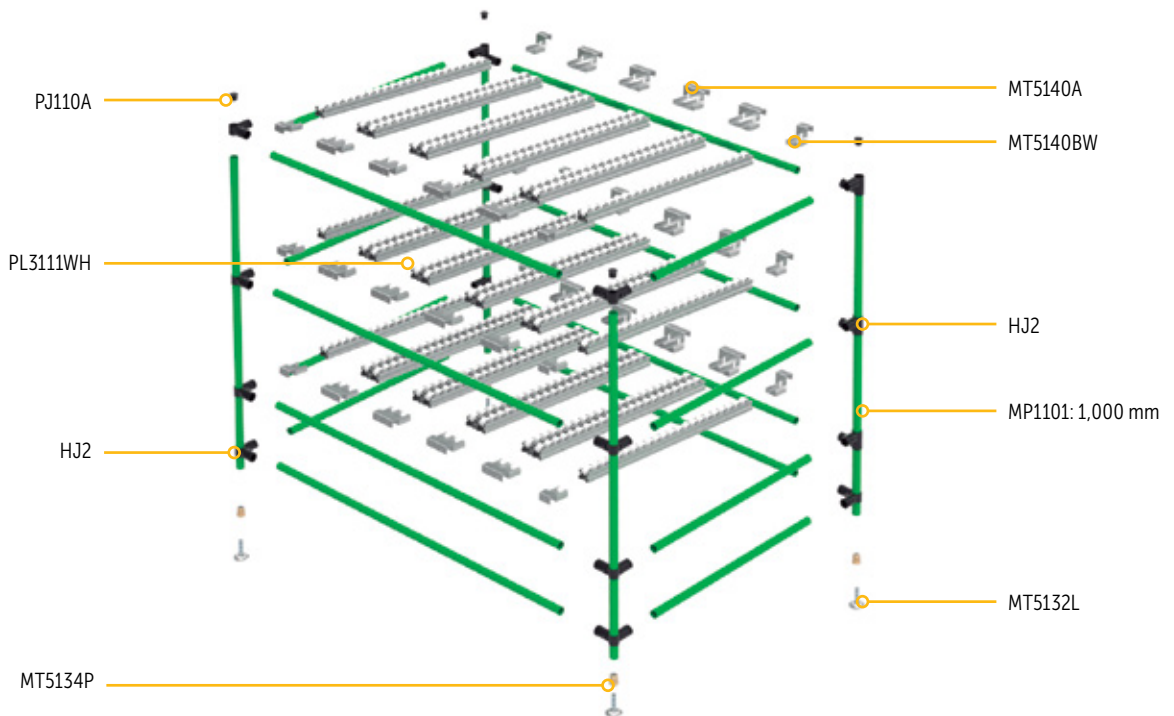

APLICACIONES





APLICACIONES

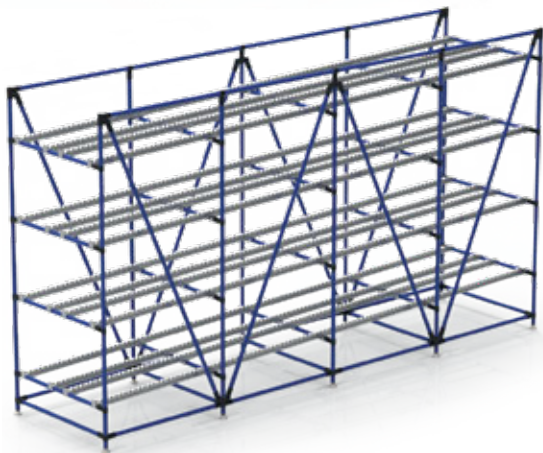



- 📍 Río del Fuerte 101
Col. Jardines del Canadá
Escobedo, N.L.
- ☎️ 01 (81) 1334 0669
- ✉️ ventas@tpslean.com.mx
- 🌐 www.tpslean.com.mx





www.tpslean.com.mx

01 (81) 1334 0669

ventas@tpslean.com.mx